



Published by CREW – Scotland’s Centre of Expertise for Waters. CREW connects research and policy, delivering objective and robust research and expert opinion to support the development and implementation of water policy in Scotland. CREW is a partnership between the James Hutton Institute and all Scottish Higher Education Institutes supported by MASTS. The Centre is funded by the Scottish Government.

This document was produced by:

Alison Duffy, Brian D’Arcy and Neil Berwick,

Urban Water Technology Centre,

University of Abertay Dundee,

Kydd Building, Bell St, Dundee,

DD1 1HG.

Please reference this report as follows: Duffy. A., Berwick, N., D’Arcy, B., (2013), Source Control SUDS: Global case studies CRWRR006 (CD 2012 27). Available online at: crew.ac.uk/publications

Dissemination status: Unrestricted

All rights reserved. No part of this publication may be reproduced, modified or stored in a retrieval system without the prior written permission of CREW management. While every effort is made to ensure that the information given here is accurate, no legal responsibility is accepted for any errors, omissions or misleading statements. All statements, views and opinions expressed in this paper are attributable to the author(s) who contribute to the activities of CREW and do not necessarily represent those of the host institutions or funders.

Cover photograph courtesy of: Alison Duffy

Australia

Box 1. Source control for roads: biofiltration swale. Hume, Victoria.

This example from Hume City Council in Victoria was designed by external consultants for Hume City Council and was awarded the 2010 Australian Institute of Landscape Architects Urban Design Award and a Merit in the 2010 Stormwater Victoria Awards.

The WSUD scheme was part of a streetscape upgrade for Tanderrum Way in Broadmeadows.

The scheme uses two WSUD source controls to manage road runoff; a biofiltration swale, and a permeable paved biofiltration system.

Biofilters (also known as biofiltration systems, bioretention systems and rain gardens) are vegetated systems which have an engineered sub-base (soil, aggregate, etc) to provide treatment and infiltration. Bioswales are similar in design to the UK standard dry swale.

The bioswale is located in the central section of the carriageway which has been designed with transverse slopes so that runoff enters the bioswale as sheetflow. Runoff infiltrates through the vegetated layer into the sub-base and discharges to the ground.

Pedestrian access was required at key crossing points of the road and these have been catered for by constructing an overlain permeable pavement layer over the bioswale, enabling access whilst ensuring the road surface drains freely.

Further information on this project can be obtained from www.clearwater.asn.au

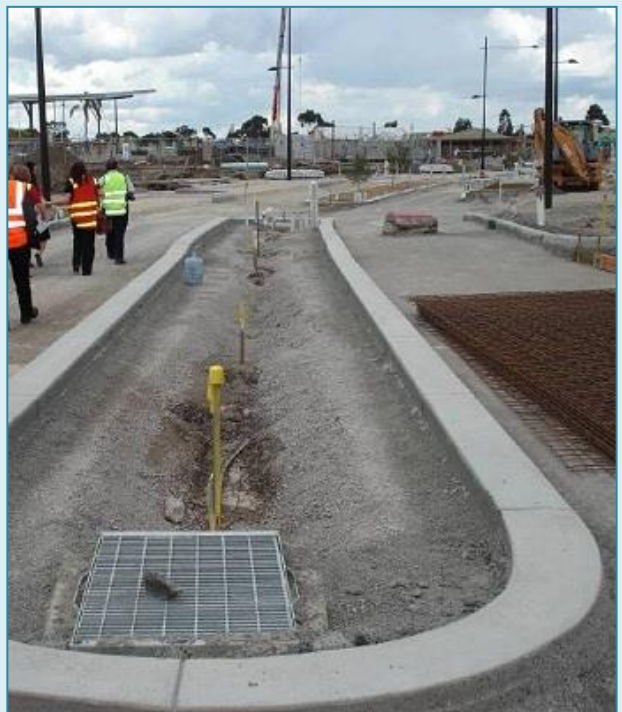
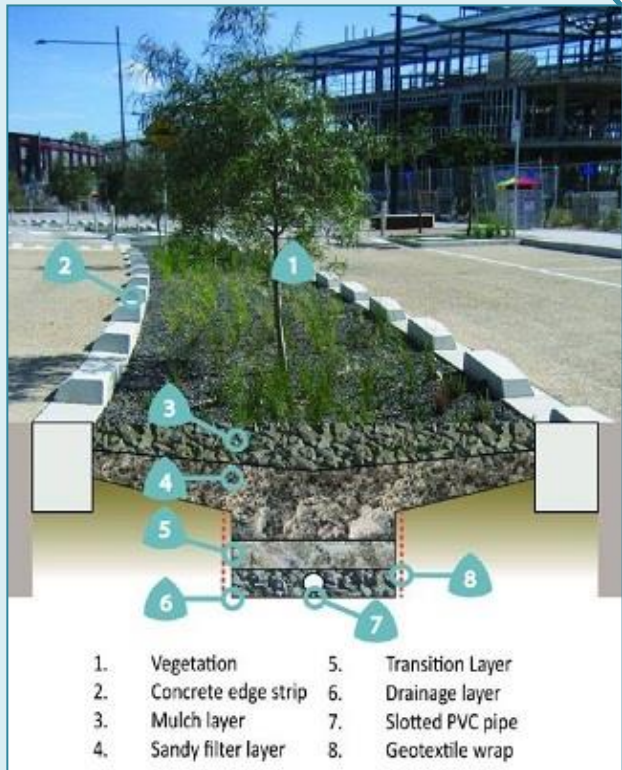

Image Source: Clearwater, 2012, courtesy of Hume City Council

Australia

Box 2. Green infrastructure source control: climbing pits. Boroondara.

This source control example was implemented on Glenferrie Road in Boroondara.

The road is a busy thoroughfare and commercial area where available space for retrofit of WSUD techniques was extremely limited. The main driver for the project was the greening of a busy commercial area.

Due to space constraints, low footprint techniques were necessary to ensure that access and businesses were not adversely affected. This precluded the use of most source control techniques including tree pits.

Vegetated climbing pits were designed and installed along the footway. Three climbing pits receive runoff from the road surface and the footway via pre-cast concrete kerb slots. The engineered filter base provides a medium for the plant rootmass, and the cylindrical wire frame allows the plant to climb and establish.

Regular maintenance of the climbers was necessary in the initial period to ensure upwards and outwards growth of the plants. Ongoing maintenance post implementation has involved regular sediment removal from the surface of the filter media.

Further information on this project can be obtained from www.clearwater.asn.au

Image Source: Google Earth (image a) Clearwater, 2012 (images b & c)

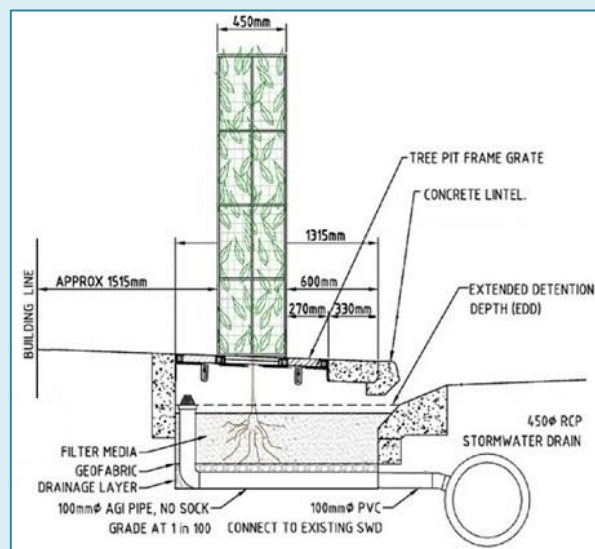

Australia

Box 3. Bioretention implementation challenges, Sydney.

This case study illustrates some of the challenges to implementation of bioretention source control pods in Sydney.

These bioretention units were designed to drain both the road and footway for a new development. Runoff drains from the surrounding hard surfaces as sheet flow and infiltrates through the engineered sub-base into the surrounding soils.

Image 1 shows the bioretention system shortly after planting; flow from the road and footway is eroding the mulch layer and damaging the plants.

In Image 2 temporary preventative measures have been introduced: porous gravel bags placed at inlet to reduce flow into the bioretention unit and the base has been reinstated. Note: the plants are yet to be replaced at this stage. Once the plants have become established the temporary measures can be removed and the unit brought on-line.

Image 3 shows how temporary baffles have been used within a nearby bioretention unit. The baffles are placed at short intervals to protect the plants as they bed in, acting like check dams to slow flow as it passes through the unit, reducing erosion and plant damage. Note the inspection pits within each baffled section.

In Image 4 vegetation establishment is now complete and the temporary measures have been removed; the bioretention system is now fully online and fit for purpose.

Ongoing maintenance of the unit is minimal, requiring regular inspection, litter and sediment removal, and where necessary replacement of the mulch layer and plant die off.

It is important that suitable plant species are selected which are tolerant to both wet and dry conditions. Regular inspection and maintenance visits should be carried out during the initial period to ensure establishment.

Information and Image Source: WSUD in Sydney Program, 2010



Australia

Box 4. In-plot source control: bioretention, Melbourne

Melbourne Water, the state owned water authority, is actively promoting in-plot source control. A public campaign is underway to create 10,000 raingardens in Victoria; at time of writing the number is just over 8,000.

The campaign promotes the benefits of source control in protecting natural water resources as well as creating a green biodiverse garden, and is aimed at homeowners.

Information on the design and construction of various types of in-plot bioretention units is available on the project website including planter boxes, in-ground raingardens and infiltration raingardens. Residents are encouraged to disconnect the downpipes from their properties and divert runoff to their garden bioretention unit.

The public campaign focuses on awareness and 'doing your bit for the community'. Once the homeowner has built their raingarden and disconnected the roof downpipe the location of the raingarden can be added to the project website.

The campaign includes both public and private assets, however the target is the construction of privately owned assets. The project is not restricted solely to raingardens; there are also design guides for in-plot permeable paving, green roofs, rainwater tanks and swales.

More information can be found at:
<http://raingardens.melbournewater.com.au>

Information and Image Source: Melbourne Water (2013).

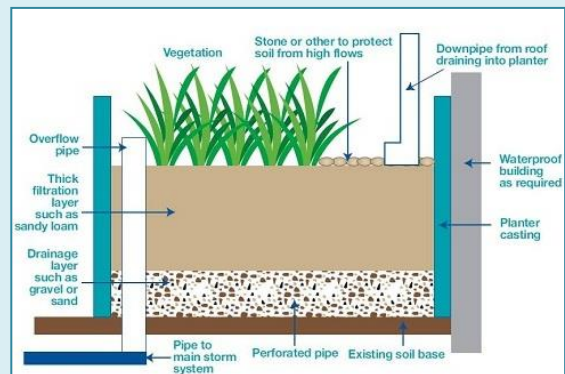
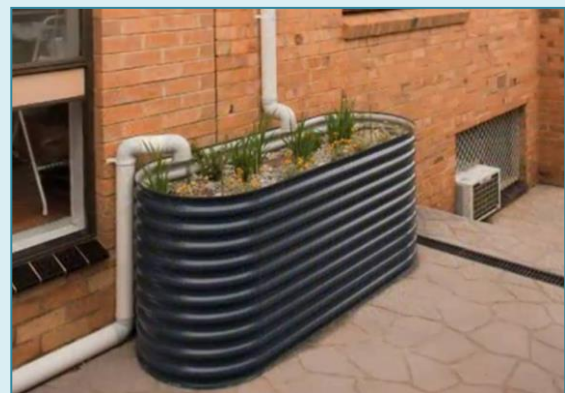

Germany

Box 5: Source control for combined commercial, retail and residential building: raingardens, small ponds, rainwater harvesting for air conditioning (waterwalls), fire fighting and irrigation. Nuremberg.

This example was implemented by the Karlsruher Lebensversicherung AG insurance company and designed by Joachim Elbe Architektut Tübingen, Atelier Dreiseitl and Dr Wilhelm Stahl.

The Prisma Nuremberg complex comprises residential and commercial premises with a total area of 6,000m². The ground floor has retail facilities (stores and cafe), 2-4th floors are offices and 5-6th floors are residential.

All stormwater is managed on site whilst creating a pleasant and comfortable living and working environment.

All rainwater is collected into an underground cistern after passing through raingardens and small ponds for treatment. It is then pumped to two different circulation systems: the 1st is used for irrigating plants and feeds a small watercourse which runs through the complex; the 2nd is used for natural air conditioning where water is pumped to five water walls decorated with coloured glass which pulls air down – in the summer the falling water cools the air and in winter it warms the air (~18⁰C).

Further information can be obtained from <http://www-cenergensmp.fr/ease/CS1-GER.PDF>

Image Source: 1, 3 and 4 © Atelier Dreiseitl and 2 © J. Hoyer

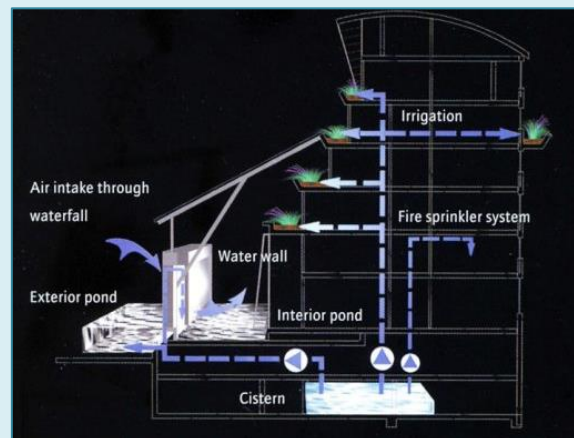

Germany

Box 6: Bioretention Unit INNODRAIN® Emschergenossenschaft.

The INNODRAIN® system which is used extensively in the Emscher region in Germany represents a universally applicable technical solution for sustainable rainwater management in the form of on-site retention (source control) in street locations.

The system core components are the deep bed surrounded by a concrete frame which is situated 20-30cm below street level, a trench which contains Rigofill crates or soil / gravel layer for infiltration and storage benefits and pipework for connection with other systems and / or discharge of overflows if infiltration is not possible. A high strength geotextile is also required to reduce fine particles and tree root penetration.

Stormwater is treated as it passes through vegetation on the surface and through the deep bed. Storage capacity can be sized to ensure undeveloped flow rates to minimize hydraulic load on sewers and provide de-centralised temporary storage. Infiltration provides groundwater recharge benefits in urban areas if applicable.

According to experience INNODRAIN® long-term maintenance costs are no higher than traditional drainage costs which do not offer infiltration or treatment benefits.

For more information and image source see <http://www.sieker.de/english/>

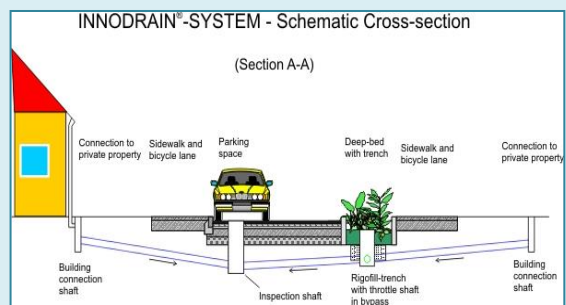
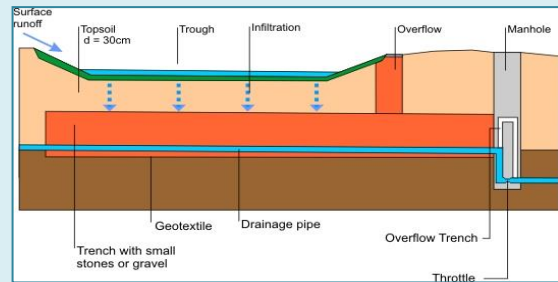

Germany

Box 7: Integrated Source Control. Hohlgrabenäcker, Stuttgart

New residential development that is sustainable with cost effective stormwater management through the application of green roofs, cisterns and permeable paving. The development is 16.7ha (green roof area is 18,300m²) which incorporates 265 private homes and 9 apartment buildings with restricted flow (30%) to the stormwater sewer due to limited capacity.



Infiltration techniques were unsuitable. Green roofs were specified in the Stuttgart development plan in the more dense areas: *“For the retention of stormwater, areas with flat and single-pitch roofs are to be covered with green roofs. [...] The green roof must have a substrate depth of at least 120mm. The substrate layer is to be planted with grasses and wildflowers and shall be preserved as such.”*



For areas with single or semi-detached houses rainwater cisterns that collect rainwater from the roofs and paved areas were installed. The cisterns overflow to the stormwater sewer during extreme storm events. Homeowners can use the water collected in the cistern for irrigation, flushing toilets and washing clothes. Public areas flow to a new stormwater sewer that directly discharges into the receiving watercourse. To reduce soil sealing public streets and paths are restricted to a minimum and permeable paving has been applied where possible. Overall imperviousness was reduced to a total of 20% for the entire residential area. An economic comparison showed that WLC which includes investment costs and running costs, are less than the costs for conventional solutions.



For more information see
[http://www.switchurbanwater.eu/outputs/pdfs/W5-1 GEN MAN D5.1.5 Manual on WSUD.pdf](http://www.switchurbanwater.eu/outputs/pdfs/W5-1_GEN_MAN_D5.1.5_Manual_on_WSUD.pdf)
Images © J. Hoyer

Netherlands

Box 8: Waterplan 2: Decentralisation of Stormwater (disconnection). Rotterdam.

Rotterdam is Europe's biggest harbour and is located 2m below sea level. Heavy rain and limited sewer and pumping station capacity lead to flooding problems with climate change impacts posing a serious threat. In response Waterplan 2 was developed - a comprehensive joint approach to spatial planning and water management. The main concept is to use water as an opportunity to make the city more attractive by creating and implementing new solutions for stormwater storage in densely built urban areas and by following an integrative approach.

Rotterdam Waterplan 2 aims:

- Protect Rotterdam against flooding, both inside and outside the dykes.
- Ensure water quality required by the EU WFD to improve the cities' amenity.
- Integrate urban planning with water management to solve water problems and enhance the city's attractiveness as a place to live, work and relax.
- Reorganize stormwater runoff via decentralised innovative solutions.

One of the most innovative solutions is the water square. Invented by De Urbanisten and Studio Marco Vermeulen, this solution contributes to the quality of public space and uses technical systems to manage stormwater. During dry periods (90% of the year), the square is used as an open public space, during heavy rainfall rainwater flows visibly into the square – starting at the playground area, filling the carefully arranged hollows in the ground and gradually creates streams, brooks and small ponds. If the rain lasts longer, the sports field also acts as a temporary storage facility. The water square can hold a maximum of 1,000 m³.

For more information: switchurbanwater.eu/outputs/pdfs
Image source © De Urbanisten

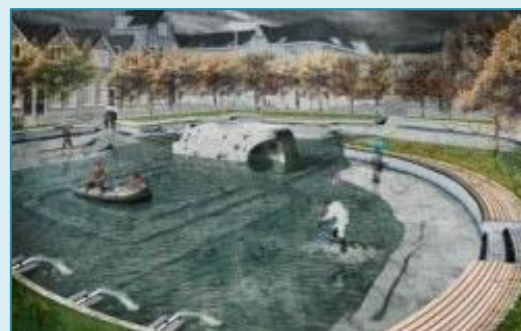

South Korea

Box 9: Source Control SUDS. South Korea.

A Gwangju resort near Seoul has an extensive permeable pavement car park which provides storm water attenuation and treatment with zero land take.

An overflow drain for extreme conditions runs across the surface of the car park. Access roads drainage falls to a large open stone filter drain, which spills to a landscaped channel into a retention reservoir for landscape use on site during dry months.

The green aspect (plants on the car park surface) is a good landscape fit with the surrounding woodland and the green rural context of the resort development.

The challenge of retrofitting source control to improve existing water quality can be illustrated by the full-scale experimental systems at the Kongju National University campus. These systems investigate the practicality of various filtration options for road and car park drainage. Such technology can be retrofitted to address existing urban diffuse pollution problems.

The systems include a composite filtration unit “Eco-Biofilter”, and modular drainage tree planter.

For more information and image source see Kim., L-H, and D’Arcy, B.J. (2011). South Korean BMPs and stormwater management. IWA Water 21 Article, pp36-38, August.



Sweden

Box 10: Urban Regeneration Source Control. Augustenborg, Malmö

Drivers for a regeneration initiative in the late 1990s included tackling pluvial flooding, difficult social and economic issues and biodiversity improvement.

In order to minimise flood risk, rainwater from roof tops and other impervious surfaces was disconnected from the existing combined sewer and drained by means of a novel open system. The main aim was to reduce flooding by 70% to eliminate combined sewer overflows completely by reducing the total volume of stormwater and peak flow rates. This was achieved by reducing impervious areas, preserving and enhancing green spaces, and managing stormwater to reduce total runoff.

The novel above ground drainage system was created in cooperation with MKB, the Water Department, landscape designers, and local residents interested in water management issues. It includes 6km of canals and water channels and ten retention ponds. Rainfall is collected in natural ditches and reservoirs before discharging into the conventional sewer network. The landscape features are integrated into the townscape which also provides recreational green spaces. Some of the green spaces can be temporarily flooded, which helps slow rainwater into the conventional sewer.

In addition, green roofs have been installed on all developments built before 1998. The Botanical Roof Garden, which covers 9,500m² of an old industrial roof, is the largest green roof in Scandinavia

For more information see

<http://www.grabs-eu.org/membersArea/files/malmo.pdf>

Images Alison Duffy

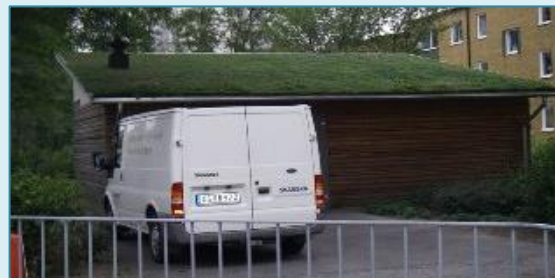

Sweden

Box 11: Industrial Redevelopment Source Control. Western Harbour, Malmö

Western Harbour is a redevelopment of an industrial shipyard into a new housing project. The development began with the European Housing Exposition in 2001: Bo01 - The City of Tomorrow with a focus on sustainability. Biological diversity is a key component to all of the open spaces through implementation of innovative stormwater management techniques through disconnection of roof water which is directed into open channels and bioretention areas and green roofs.

Perhaps one of the most innovative strategies used in new developments such as Western Harbour (and Augustenborg) is the minimum standard requirement for Green Area Factors, also called Biotope Area Factor (BAF). This is a tool used to measure an ecologically effective land area of a development which is defined as 'the area of a development that contributes to an ecosystem function through stormwater drainage or habitat'. Surfaces such as grass, gravel, vegetation, and green roofs are given a score rating based on how much they contribute to an ecosystem function, i.e. a surface of concrete receives a score of 0.0 while a green roof a score of 0.7 and vegetated surfaces receive the highest score of 1.0. This rating is then multiplied by the total area that the feature covers in the development. Adding up all of these scores gives the ecologically effective area which is then divided by the total development area to give a final green area score. The City of Malmö sets minimum standards for what this score has to be. The developer then has the freedom to implement any number of green features to reach the score.

For more information see

http://depts.washington.edu/open2100/Resource/s/1_OpenSpaceSystems/Open_Space_Systems/Malmo_Case_Study.pdf

Images Alison Duffy



Box 12. Residential source control: in-plot swales, Montrose.

This residential development in Montrose uses source control to manage roof and road runoff for 67 houses.

Road and roof drainage is managed using a series of small roadside swales.

Where ground conditions permit the swales are designed for infiltration. Where ground conditions are unsuitable for infiltration, the swales convey runoff to an infiltration basin located within public open space.

The system is designed to manage storm events for up to the 1 in 10 year event. Flood routing is catered for using the roadway.

The swales are located within a narrow service strip which borders the adjacent gardens; there is no obvious delineation between the two and the title deeds of each property contain burdens stipulating regular maintenance (grass cutting) of the swales.

Where swales are intersected by access driveways cover plate beanie are used to convey water under the impervious drive section.

In principle this arrangement ensures that the swales are maintained, however this presents the challenge of regulating the standards of maintenance across the development.

Image Source: Google Earth (a) and Muir Homes and Pell Frischman McGovern (b and c).

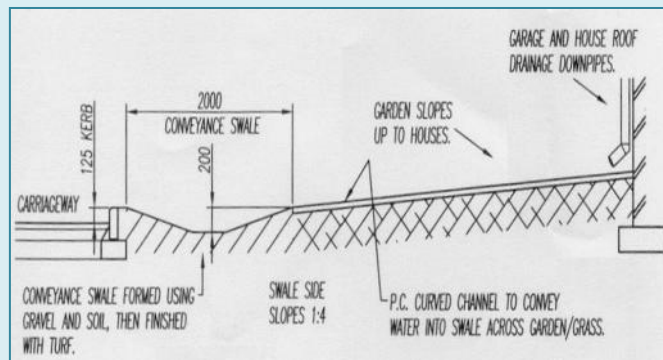
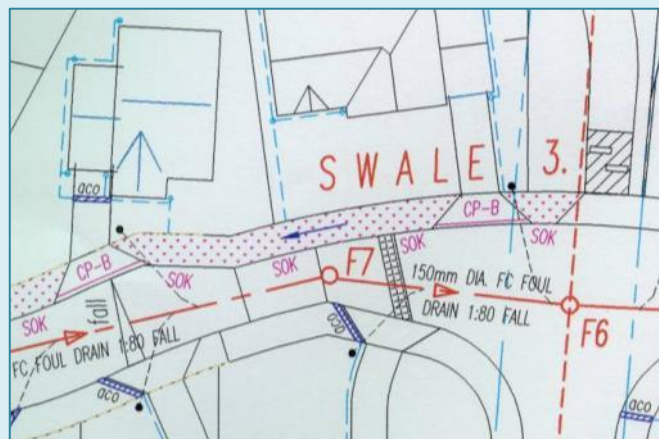

Box 13: Residential source control: in-plot soakaway, Kemnay.

This residential development is located within Kemnay, Aberdeenshire. The site comprises of 96 plots, access road and public open space.

The ground is suitable for infiltration and source control soakaways are used for all plots with the exception of four, where infiltration is not possible; these units are drained by a short piped network connecting to the surface water network draining the road.

The site demonstrates how infiltration techniques can be used to manage surface water locally and with minimum land requirement; trench soakaways are located within the curtilage of each property and the site control soakaway tanks (serving the road) are located in areas of public open space near to the access roads and are grassed over to form amenity space.

There are two notable challenges with maintaining the the site; the road soakaway tanks have only pre-treatment by gullies which if not suitably maintained may lead to siltation of the tanks, and the plot level soakaways are located to the rear of the property making access more difficult for the management company responsible for inspecting the soakaways.

Locating source control soakaways within the curtilage of each property places the burden with the homeowner to ensure their continued operation and should the unit fail the problem will be visible and localised, encouraging the homeowner to make good the defect.

Image Source: Greenbelt Group Ltd and Neil Berwick, University of Abertay Dundee.

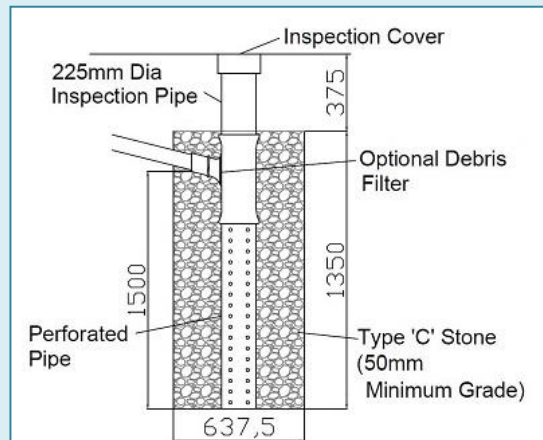

Soakaway Trench Detail

3m Long x 0.85m Wide x 1.5 Deep

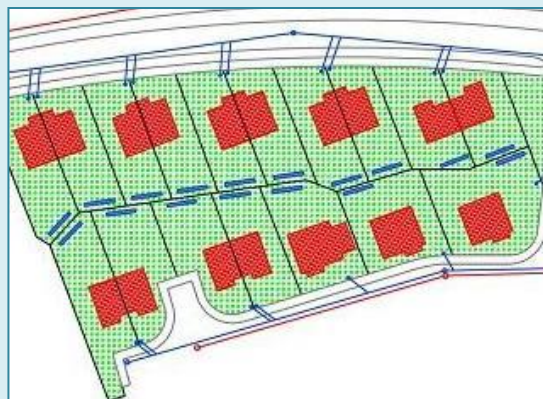

**Box 14. Residential source control:
shared surface permeable paving,
Wauchope Square, Edinburgh.**

Wauchope Square is located in Craigmillar, Edinburgh and is an area which has undergone extensive redevelopment. The existing site is a high density residential area where space was at a premium.

The redevelopment is based upon the principles of *Designing Streets* (2010) adopting the concept of a Home Zone where:

- Pedestrian have equal priority of space.
- The road space allows for traffic but is not delineated for it.
- The design of the space is from wall to wall of the street in terms of surface treatment.
- The soft landscape is an integral part of the street layout.

The scoping stage identified low footprint techniques including, permeable pavements, bioretention, sand filters, modular tanks and porous asphalt. The sensitivity of the receiving water dictated a second level of treatment necessary, excluding modular tanks and sand filters.

Permeable pavement was chosen predominantly due to space restrictions and there was higher confidence with installation and ongoing maintenance opposed to the other options.

A variety of different permeable and impermeable pavements and block types are used throughout the extent of the development. High trafficked areas use impermeable blocks with the road geometry designed to drain towards low trafficked impermeable sections.

Different paving sets were used so that services corridors could be easily identified for future maintenance.

Image Source: Ian Whyte Associates (Fig a & b) and SUDS for Roads (2010) (Fig c & d).



Box 15. Industrial source control: J4M8, central belt, Scotland.

The J4M8 Distribution Park is located at junction 4 of the M8 motorway, linking Edinburgh and Glasgow.

The site comprises of an area of 76 hectares and development has been undertaken in phases over a period of 10 years.

A combination of source, site and regional controls has been used and the stormwater management train is an example of an (almost) pipeless system.

Each plot uses source and site controls to treat, attenuate runoff, and isolate local spillages or pollution events. The access road uses roadside swales providing source control and conveyance to the regional wet ponds. Available land has not been a restriction on the site and subsequently the use of source controls is varied; examples include filter trenches, permeable paving, gravel filter beds and small linear swales.

The roadside swales are considerably larger than would be used for residential sites and incorporate an extended bank adjacent to the road acting as a filter strip for pre-treatment. The swales have been allowed to naturalise with a variety of local wetland species, providing additional treatment and visual / biodiversity benefits.

The road drains as sheet-flow over a flush kerb into the swale, reducing localised build of silts and ponding. However this detail has incurred additional maintenance with HGVs over-running the road and damaging the filter strip and swale banks. A preventative measure of stone boulders has been used at the road edge, although this would not be acceptable if the road was adopted by the local authority.

Image Source: Neil Berwick, University of Abertay Dundee.

Treatment Control Level	SUDS Technique							
	Filter drain	Swale	Porous paving	Permeable block paving	Buried filter media	Detention basin	Pond	Wetland
Source	X	X	X	X				
Site					X	X	X	
Regional							X	X

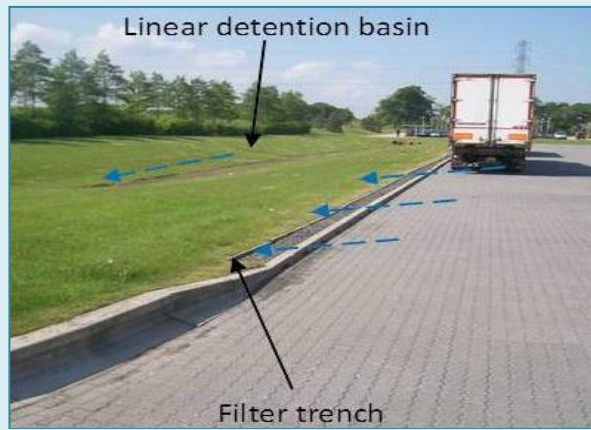

Box 16: Integrated grey (kerb channels) and green (swale) SUDS solution. Henry Box Development, Oxfordshire

A development of 92 houses in an Oxfordshire floodplain with runoff volume limitations for the 1.1ha site were 9.5l/s, traditional drainage methods were not deemed appropriate by the LA. The solution was based on careful integration of engineered products such as combined kerb drainage units with on-site mass attenuation, this linking to swales for quality treatment. A study of rainfall event impact over an 18 month period has validated the design.



Requirements from the Environment Agency, Council and developer included:

- No development within 25m of the existing watercourse.
- No discharge above the existing greenfield rate, calculated as 9.5l/s
- The use of source control where possible
- No increase in site levels and no raised traffic calming features.
- All walls to be provided with gaps to allow the passage of water.
- An additional 'shelf' to be constructed adjacent to the watercourse.

Given the site characteristics, controlling at source through infiltration was impossible as was the traditional alternative which would require trenches of increasing depth. Managing conveyance across a virtually flat site was required. The design scheme proposed by engineers Atkins incorporated extensive channel drain systems using combined kerb linear channel drainage units with further use of conventional channels to integrate system components. This enabled convenient connection of roof drainage from each dwelling. The combined kerb drainage units had a 325mm level invert installed within a concrete surround to meet the load requirements of BS EN 1433 (2002). The high invert of the conveyance system enabled relatively shallow attenuation or storage tanks, which were then able to connect to surface swales and on to the local water course.

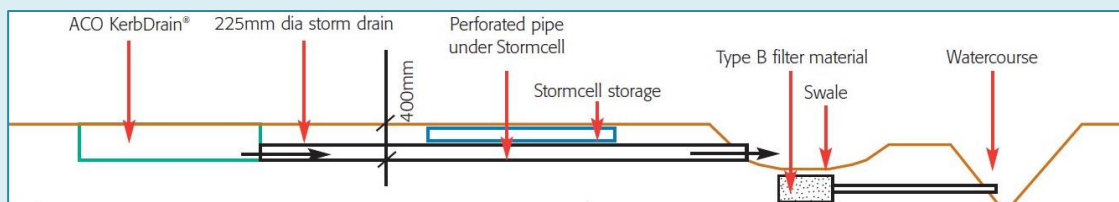

For more information and image source see <http://www.aco.co.uk/suds.php>

Box 17. Residential in-plot retrofit: raingarden, Islington, London.

Islington Council in association with Homes for Islington and other partners have retrofitted a raingarden into an area of open space within a social housing block in Islington, London.

The scheme involved disconnection of a 30sq M area of roofwater from the block which is channelled by a cobbled rill to the raingarden for infiltration. The raingarden has been designed to manage the 1:100 year return period storm plus 30% for climate change; exceedance flow re-directed to the sewer.

In addition to reducing flow to the existing sewer, the project was designed to improve the local environment for the residents. Stakeholder engagement with the local community at the design stage helped to support acceptance of the scheme. The raingarden has been located on the corner of the plot to maximise visibility (and to tie in with the existing downpipe).

The planting specification for the raingarden has included colourful local plants to draw the eye and provide an attractive focal point. In addition to colour, plant species were selected that were robust and easy to maintain.

The site is one of a number of innovative SUDS pilot projects being undertaken by Islington Council and the performance of the raingarden is being monitored by Middlesex University.

Further information can be found at: www.islington.gov.uk

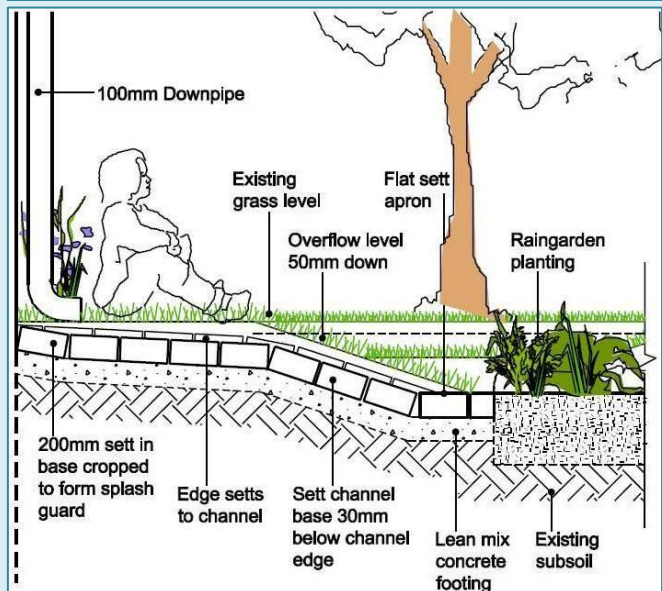

Information and image source: Bob Bray (Robert Bray Associates).

Box 18. Source control retrofit: blue roof research, New York City.

Blue roofs are a new LID concept and are being developed in the USA. Blue roofs are roofs engineered from using traditional materials which feature an array of structures to provide attenuation of rainfall and control discharge, including filter and attenuation structures, baffles, checkdams and flow controls. Blue roofs are particularly useful in warmer climates where stored rainfall can evaporate, thus reducing the flow to downstream LIDs.

Blue roof development is being undertaken in New York as part of the City's green infrastructure plan which seeks to reduce the area of impervious surfaces connected directly to the combined sewer system by 10%. New York has a high proportion of flat roofed buildings per acre presenting an opportunity to deliver in part this target without the need for additional land take for retrofit LIDs.

Blue roofs, unlike green roofs, can only be used on flat roofs, relying on structural element to detain water. Studies have shown that construction costs for blue roofs are low with values of \$1 per square foot (Environmental Protection Online, April 6th, 2010).

The test site at Metropolitan Avenue in Brooklyn was used to test the performance of new blue roof designs. This study was based solely upon reducing runoff from the building roof and did not address any other potential benefits such as habitat potential. The study site was a 'flat' roof with a shallow fall from the centre to the perimeter of the rooftop.

Image Source: HDR Hydroqual Inc, 2012 (Images a & c), nyc.gov online (Image b) & NYC Environmental Protection, 2010 (Image d).

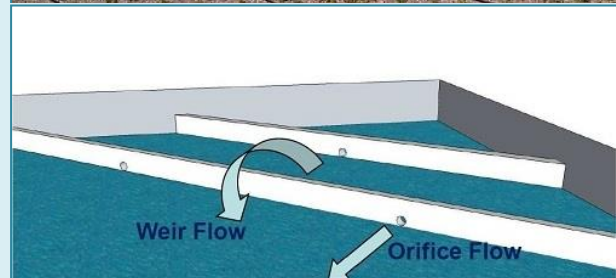

Box 19. LID neighbourhood retrofit, Elmer Avenue, Los Angeles

Los Angeles is a city which faces severe water management challenges; flooding in winter and droughts in summer.

The Elmer Avenue neighbourhood was an area earmarked for re-development and LID techniques were incorporated into the project to manage water management on a local scale.

Infiltration of runoff into the water table was the key driver of the scheme. This was achieved using a combination of 24 bioswales at the road edge, porous road surfaces and underground 'infiltration galleries' manage roof and road runoff.

More than half of the property owners agreed to convert their front gardens to "California friendly" gardens to manage runoff. These properties also had rain barrels with high efficiency drip irrigation connected to manage a proportion of the roofwater.

Key benefits of the scheme include:

- Up to 5.4 million gallons of runoff infiltrated annually.
- Reduction in potable water use by 30% for homeowners with enhanced front yards and 10% for others, saving homeowners \$120-\$360 annually.
- Increased resident understanding of in-plot LIDs. Only 60% of survey respondents agreed with this statement in 2006 compared to 100% in 2011.

Further information on this project can be obtained from: <http://lafoundation.org>

Information and Image Source: Landscape Architecture Foundation, 2013



Box 20. Plot based downpipe disconnection to green areas or other retrofit control.

Where downpipes from buildings are connected to combined sewer systems, then disconnection can be advantageous. Doing so will reduce flows to waste water treatment plants (reducing cost of treatment) and minimise frequency of spills from combined sewer overflows into watercourses.

Disconnection is a simple option to managing runoff at source and in high density may be one of the few cost-effective retrofit options. There are many incentivised schemes in the USA to encourage homeowners to disconnect roofwater from the sewer

Disconnection can typically be achieved using two main methods:

- i. Diverting downpipes so that rainfall from the roof area is directed towards green areas so that it slowly infiltrates into the ground.
- i. Diverting downpipes so that rainfall is channelled to a retrofit control.

The first option, redirecting to green areas, is a simple and cost effective process however it will depend upon available open space, soil infiltration properties, levels and volume of runoff to be infiltrated.

Most examples of disconnection will require retrofitting local source controls within the area - these are typically soft engineered LIDS which are usually low cost options to implement and maintain (although this will depend on the type of technique used).

Image Source: USEPA, 2010 (image a), www.lowimpactdevelopment.org (images b & c).



Box 21. Porous paving carpark at Far Rockaway, Queens, NYC

This Department of Transportation municipal park and ride car park is a test site used to assess the performance of two types of porous pavements designed for infiltration, with a control area of standard asphalt.

The pavement consists of the porous surface with 450mm aggregate and a slotted underdrain pipe connecting to the combined sewer.

The two porous pavement types installed were:

- i. Porous asphalt, and
- ii. Filter pave, a porous surface made from reclaimed glass.

Vertical barriers were installed between the three pavement surfaces and the pavements have been studied to assess both their hydraulic performance and their durability.

Initial results (NYC Environmental Protection, 2012) show that:

- Both porous pavements have provided 100% volume retention without any noticeable discharge to the combined sewer.
- The porous asphalt has remained intact during the test period however the reclaimed glass surface has shown signs of wear (surface wear chipping, and rutting).

For more information see:

http://www.nyc.gov/html/dep/html/stormwater/nyc_green_infrastructure_plan.shtml

Image Source: McCloughlin et al., 2012 (image a), NYC Environmental Protection, 2012 (image b)



CREW Facilitation Team

James Hutton Institute

Craigiebuckler

Aberdeen AB15 8QH

Scotland UK

Tel: +44 (0) 844 928 5428

Email: enquiries@crew.ac.uk

www.crew.ac.uk

