

Water and the circular economy - where is the greatest sustainable economic benefit for resource recovery in the water cycle?





Published by CREW – Scotland's Centre of Expertise for Waters. CREW connects research and policy, delivering objective and robust research and expert opinion to support the development and implementation of water policy in Scotland. CREW is a partnership between the James Hutton Institute and all Scottish Higher Education Institutes supported by MASTS. The Centre is funded by the Scottish Government.

This document was produced by:

Davide Dionisi, Josie Geris, Ifeoluwa Bolaji
University of Aberdeen

Please reference this report as follows: D. Dionisi, J. Geris, I. Bolaji (2018) Water and the circular economy – Where is the greatest sustainable economic benefit for resource recovery in the water cycle? CRW2017_17. Available online at: www.crew.ac.uk/publications.

Dissemination status: Unrestricted.

Copyright: All rights reserved. No part of this publication may be reproduced, modified or stored in a retrieval system without the prior written permission of CREW management. While every effort is made to ensure that the information given here is accurate, no legal responsibility is accepted for any errors, omissions or misleading statements. All statements, views and opinions expressed in this paper are attributable to the author(s) who contribute to the activities of CREW and do not necessarily represent those of the host institutions or funders.

Acknowledgements:

The authors wish to acknowledge the assistance of Jannette MacDonald (CREW) for the project management, Prof Elise Cartmell (Scottish Water) for the useful discussion of the work, Callum Wright (Scottish Water) for obtaining the data on wastewater composition, and all the other partners at SEPA, Zero Waste Scotland, Scottish Water, James Hutton Institute and The Scottish Government who contributed to the discussion of the project.

Cover photographs courtesy of:

- 1) By Lynn Betts - U.S. Department of Agriculture, Natural Resources Conservation Service. Photo no. NRCSIA99241, Public Domain, <https://commons.wikimedia.org/w/index.php?curid=6303636>;
- 2) By Paul McLroy, CC BY-SA 2.0, <https://commons.wikimedia.org/w/index.php?curid=12500248>
- 3) By Richard Webb, CC BY-SA 2.0, <https://commons.wikimedia.org/w/index.php?curid=9153664>;

Research Summary

Water and the Circular Economy - Where is the Greatest Sustainable Economic Benefit for Resource Recovery in the Water Cycle?

Research questions

- Which resources can be, in principle, recovered or obtained from water in Scotland?
- What is the total amount of each resource that is present in, or can be obtained from, different water sources in Scotland?
- Which maximum market value and potential savings in energy and carbon dioxide emissions could be achieved when assuming 100% recovery of each resource?

Key Assumptions

The calculations in this report are based on the total amount of resources present in Scottish waters. It is important to note that all market values, energy and carbon dioxide savings calculated in this study do not consider the possible costs, energy, and carbon dioxide emissions due to the recovery technologies. These factors should, however, be considered to determine the economic and environmental feasibility of recovering each resource. Hence, the reported maximum potential benefits, which assume total recovery of the indicated resources, must be interpreted with caution. We have considered the following resources in this study: inorganic materials (N, M, Ca, K) from raw waters and wastewaters; organic materials (cellulose and biosolids); energy from heat pumps and anaerobic digestion; hydrogen from electrolysis of treated wastewaters. These resources were assessed in terms of the amount of resource, market value, potential energy and carbon dioxide savings, technology readiness level.

Main findings

- The most significant potential lies in the recovery of energy from raw water and wastewater with heat pumps. We calculated that this recovery could generate up to approximately 5,800 GWh per year (which corresponds to approximately 7 % of Scotland's heat energy usage), corresponding to an economic value of approximately £200 M/y;
- Anaerobic digestion of wastewaters can also generate significant amount of resources, in particular methane (25,000 t/y), energy (450 GWh/y) and CO₂ savings (94 kt/y), with a total economic value of £22 M/y;

- If we include other organic solid waste in Scotland, in addition to wastewaters, anaerobic digestion could generate over 1 Mt of methane per year, with economic value of over £550 M/y;
- Recovery of biopolymers (Polyhydroxyalkanoates, PHAs, polylactic acid, PLA) also has the potential to give high economic value. However their recovery from wastewaters is still at a lower technology readiness level (TRL);
- Recovery of inorganic materials give relatively lower economic value, energy and CO₂ savings;
- The electrolysis of treated wastewaters can potentially generate very large amounts of hydrogen, although this technology is at a lower TRL.

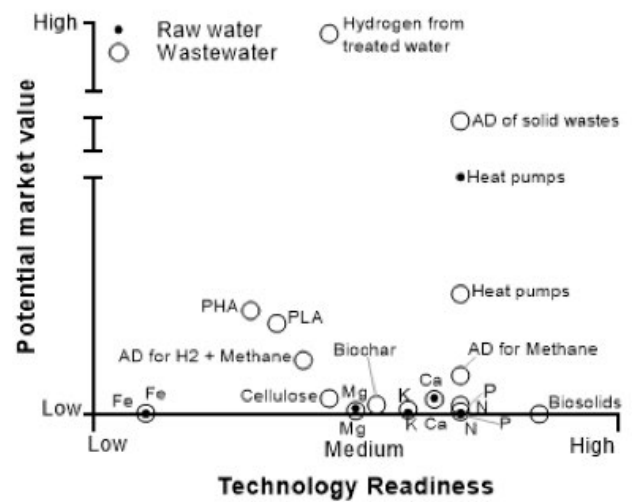

Figure: Graphical representation of the estimated benefits in the abstracted raw water and wastewater against the technology readiness of the recovery process.

Background

In the context of the circular economy, it is essential to try and recover as many resources as possible from the water cycle. Many possible resources can, in principle, be recovered from waters and wastewaters, e.g., inorganic and organic materials and energy. However, it is not known how much of each resource is present or can be obtained from waters or wastewaters in Scotland, and the potential energy and carbon dioxide savings that could be obtained from the recovery of these resources. This study is aimed at investigating the amount of the most important resources present in Scottish waters and wastewaters, their economic value, and the maximum energy and carbon dioxide savings which we could potentially obtain if we recovered these resources.

Research undertaken

We calculated the amount of each resource (N, P, K, Mg, Ca, Fe, heat, methane and hydrogen) which is present or can be obtained from raw waters or wastewaters in Scotland, their economic value and the maximum potential savings in energy and CO₂ emissions associated with the recovery of these resources. We also estimated the technology readiness level (TRL) of the processes needed for the recovery of these resources.

The steps in our investigation were as follows:

- We obtained the flow rates of raw waters and wastewaters in Scotland, their physical properties, and concentrations of the main components (inorganic elements, suspended solids and chemical oxygen demand (COD));
- We calculated the amount of resource potentially recoverable or obtainable based on (as appropriate) the mass flow rates of the components, known yields or energy balances;
- We calculated the economic value of each recoverable or obtainable resource, based on current market prices;

- We calculated the maximum potential energy and CO₂ savings, based on the energy and CO₂ emissions associated with the production of each resource with current processes;
- We graphically compared the recovery of the various resources on quantitative terms.

Recommendations

- Expand the current full-scale installations of heat pumps (for raw waters and wastewaters) and anaerobic digesters (for wastewaters and solid waste). Investigate the feasibility of these technologies in Scotland at a commercial scale, looking at their optimisation, costs and practical implementation. For anaerobic digestion, this includes looking at policies to favour the use of biosolids in agriculture;
- Investigate the use of electrolysis of treated wastewater as a process for hydrogen production;
- Look at research developments in the area of biopolymer (e.g. PHAs and PLA) recovery from wastewaters.

Contents

Research Summary	iii
List of Figures	vi
List of Tables	vi
Abbreviations	vii
1. Introduction	1
2. Opportunities for Resource Recovery from the water network	2
2.1 Inorganic materials	2
2.1.1 Nitrogen and phosphorus	2
2.1.2 Struvite recovery	3
2.1.3 Potassium and Magnesium	3
2.1.4 Calcium	4
2.1.5 Iron	4
2.2 Energy	4
2.2.1 Anaerobic digestion for methane production	4
2.2.2 Anaerobic digestion for hydrogen and methane production	4
2.2.3 Heat recovery	5
2.3 Organic materials	6
2.3.1 Cellulose	6
2.3.2 Biopolymers (bioplastics)	6
2.3.3 Biosolids	6
2.3.4 Biochar	6
2.4 Water	7
3. Methodology	7
3.1 Resource quantification	7
3.1.1 Inorganic materials	7
3.1.2 Organic materials	8
3.1.2 Energy	8
3.1.3 Hydrogen from treated water through electrolysis	9
3.2 Benefits	9
3.3 Technology Readiness Level	11
4. Results	12
5. Discussion	17
6. Conclusions	18
References	20
Appendix	24

List of Figures

Figure 1-1 Water distribution network	1
Figure 2-1 Possibilities for resource recovery from (the treatment of) water	2
Figure 2-2 Schematic representation of N recovery in a WWTP	3
Figure 2-3 Process flow diagram for P recovery in a WWTP	4
Figure 2-4 Schematic representation of Struvite recovery in a WWTP	5
Figure 2-5 Crystalactor for water softening	6
Figure 2-6 Schematic of biogas production through anaerobic digestion	6
Figure 2-7 Two-stage anaerobic digestion for hydrogen and biogas production	6
Figure 3-1 Outline of recovery technology readiness levels	11
Figure 4-1 Water distribution for the 2015/16 period	12
Figure 4-2 Graphical representation of the estimated benefits in the abstracted raw water and wastewater against the technology readiness of the recovery process	16
Figure 5-1 Fertiliser consumed in Scotland in 2015 and the recoverable quantity from water	17
Figure 5-2 Share of non-electrical heat demand that can be met by recovering heat from raw and wastewater	17
Figure 5-3 Total CO ₂ emissions in Scotland in 2015 compared to the potential CO ₂ savings in recovering resources from raw and wastewater. The chart is based on the data presented in Table 4-2.	18

List of Tables

Table 3-1 Parameters used to estimate the potential benefits of the inorganic materials	10
Table 3-2 Parameters used to estimate the potential benefits of the organic materials	10
Table 3-3 Parameters used to estimate the potential benefits of energy	11
Table 4-1 Average characteristics of raw water and wastewater in Scotland	12
Table 4-2 Calculated resources and benefits	14

Abbreviations

AD	Anaerobic digestion
COD	Chemical oxygen demand
CHP	Combined heat and power
DM	Dry matter
PCC	Precipitated calcium carbonate
PET	Polyethylene terephthalate
PHAs	Polyhydroxyalkanoates
PLA	Polylactic acid
RW	Raw water
SMR	Steam methane reforming
SS	Suspended solids
TRL	Technology readiness level
WW	Wastewater
WWTP	Wastewater treatment plant

1 Introduction

The water industry is increasingly working towards achieving a circular economy. Water is a valuable resource with the concept of wastewater treatment shifted from 'disposal' to 'reuse and resource recovery' for environmental, economic and social benefits (UNESCO, 2017). Figure 1-1 shows a conventional route of water use and disposal. Water use begins with the abstraction of raw water from the source (ground water, rivers, lochs, and/or reservoirs). The abstracted water is then treated to comply with drinking water standards where needed. Used water is collected from the end users through a sewerage system and channelled to the Waste Water Treatment Plant (WWTP) where its main pollutants are removed before subsequent discharge into the receiving bodies (river networks, subsurface water via re-infiltration, and eventually the ocean).

The quality of water is modified at each stage of this pathway. The main parameters (or resources) that determine the quality of water are solids, organic matter, faecal content, nitrogen, and phosphorus. Another key resource typically associated with wastewater is energy (e.g., from the organic fraction present). The quality of water depends on the origin of the raw water and the treatment methods involved in any part of the flow pathway. For example, surface water often contains clay minerals, sandy and loamy particles as well as organic remains of plants and animals. The contributing population influences the characteristics of a sewerage system. The water network in Scotland is decentralised, for this reason, the composition in the various water treatment plants will differ.

The natural water pathway is affected by multiple abstractions and discharges of water, and a balance between the natural and social cycle is vital to the ecosystem. Adopting the circular economy is an approach to improving the sustainability of the water cycle (Stanchev et al., 2017). The circular economy is characterised by closed system loops that promote maintenance, reuse, remanufacturing and recycling as techniques for improved management of resources (Saidani et al., 2017). from impoundments to implement the Water Framework Directive. Final report. WFD82. Edinburgh, UK. pp 38

The United Nations World Water Development report (UNESCO, 2017) presented the role of wastewater in the circular economy as a unified 4-step process in the: (a) source reduction and prevention of pollution, (b) contaminants removal, (c) wastewater reuse and (d) recovery of by-products. Measures for reducing domestic water distribution and consumption include:

- Use of water-efficient appliances and technologies.
- Behavioural changes to water demand.
- Reduction of leakages in water distribution.

Reducing energy and material consumption in the water cycle under the concept of the circular economy can provide sustainable long-term economic growth. Water reuse involves the indirect or direct use of treated municipal wastewater for potable or non-potable purposes. From a recovery point of view, the recovery of resources is possible at various stages in the water flow pathway. The organic and mineral matter present in wastewater represents a vast potential as resources, such as energy and nutrients, with economic and environmental benefits.

The goal of this project is to identify and quantify the available opportunities for resource recovery in the Scottish water cycle. The water network represents the active catchment areas in Scotland which include raw water (surface and groundwater) and wastewater. The project focused on four primary objectives:

- To determine the potential resources recoverable from the water network in Scotland, including raw water and wastewater;
- To quantify the available resources in the different water types (e.g., raw water or wastewater);
- To estimate the commercial value of these resources;
- To quantify the potential savings associated with the recovery of these resources, for example, energy and CO₂ savings.

This report provides a first evaluation of the total resource budgets at the national scale for Scotland, with regional differences considered via weightings where information was available. It addresses the national potential for resource recovery.

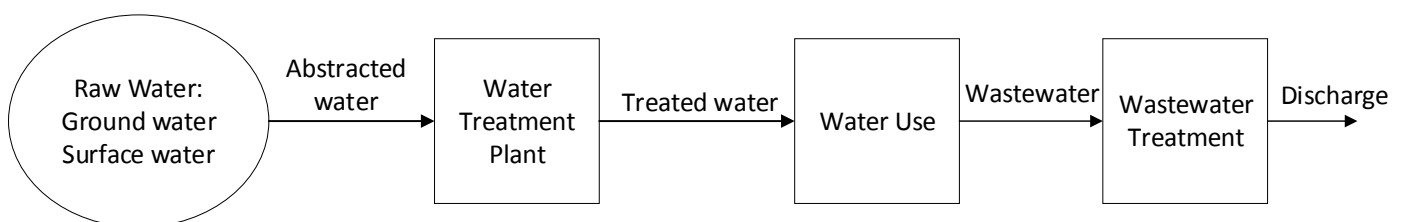

Figure 1-1 Water distribution network

This study does not investigate the costs, energy requirements and carbon dioxide emissions associated with the technologies required for resource recovery. Therefore, the economic value, energy and carbon dioxide savings reported here are the maximum potential savings without considering the recovery technology. Of course, for a full feasibility study of resource recovery, each recovery technology needs to be investigated in terms of their costs and energy requirements, to determine whether the recovery of each resource makes economic or environmental sense.

2 Opportunities for resource recovery from the water network

The primary routes for resource recovery in the water sector involve materials (inorganic and organic materials), energy, and water itself (Figure 2-1). In this report, we focussed on the recovery of inorganic materials, energy and organic materials, and not on water reuse because it was not considered a priority for this study.

Other resources which were initially considered but were not included in this report are pharmaceuticals and heavy metals. These were excluded here because they are present in low concentrations and there are currently no recovery techniques for pharmaceuticals. In particular, we could have included in our analyses either the value of lead recovery and/or the cost savings for reduction of treatment associated with pipe network improvement. However, for this, we lacked data on the extent of the affected pipe network. For sources of energy, we mainly focussed on methane, hydrogen, and heat. We did not include how energy can be recovered, e.g., via pressure, heat and/or low-head hydro from Scotland's reservoir network. Again, this was due to

the lack of data available for such analysis. Finally, the focus of raw water is on that which can potentially be abstracted from surface and groundwater bodies. We did not consider catchment management approaches such as capturing runoff (with associated resources such as nutrients) from fields, mainly because the evidence base for these technologies is limited and where available this is local and highly variable. At present, these conditions impose critical challenges for upscaling to catchment or national scales. However, research is currently being developed with regards to exploring different approaches (such as nature-based solutions for capturing runoff) and quantifying resources, so that these could be considered in the future.

2.1 Inorganic materials

2.1.1 Nitrogen and phosphorus

Nitrogen and phosphorus are primary agricultural nutrients present in fertilisers and are essential to plant growth. Nitrogen is usually present in waters as ammonia (NH₃) or nitrate (NO₃) (Sprynskyy et al., 2005). Ammonia-nitrogen in sewage results from the bacterial decomposition of the organic constituents. Ammonium salts/solution can be produced from ammonia-rich waters using stripping and adsorption (Latimer et al., 2012). Other technologies for nitrogen recovery include chemical precipitation, reverse osmosis, biological/chemical oxidation, and electrodialysis (Thompson Brewster et al., 2016; Tice and Kim, 2014). Electrodialysis is an advanced membrane technology process that utilises electrical current to separate charged and non-charged molecules.

Like nitrogen, phosphorus is also an essential macronutrient for plant growth and development (Sun et al. 2018). Phosphorus is currently produced from non-renewable

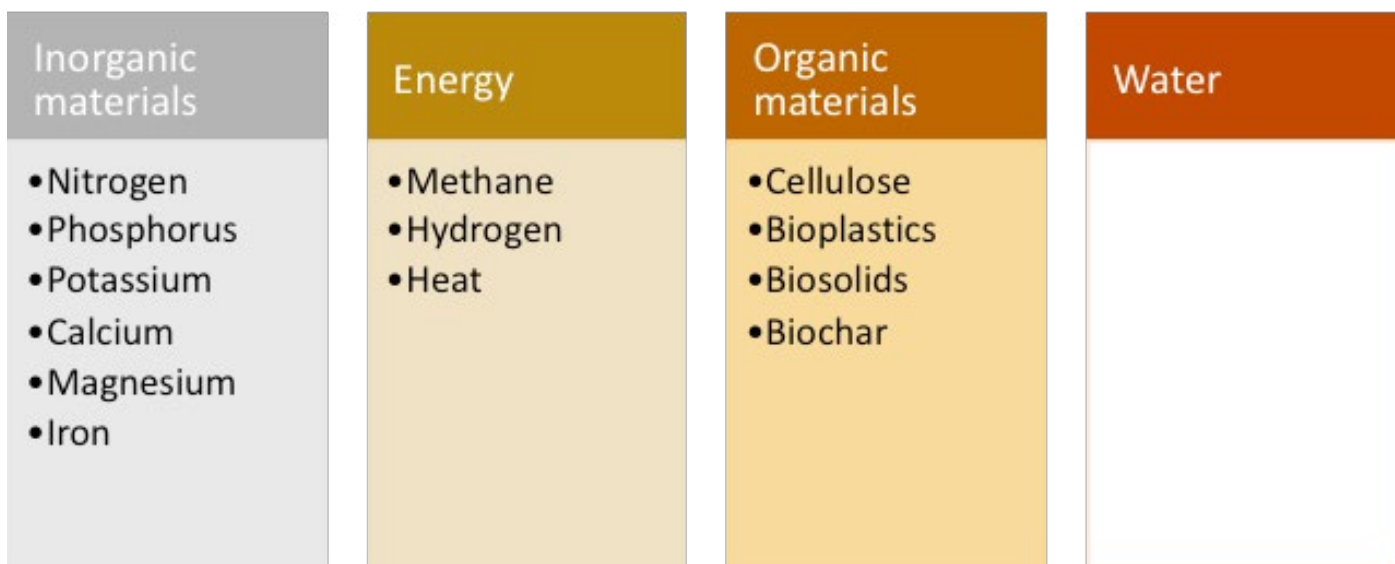

Figure 2-1 Possibilities for resource recovery from (the treatment of) water considered in this report

resources, primarily phosphate rocks. While there are contradictory literature studies on the lifetime of P reserves, the rock reserves are predicted to be exhausted for use in the next 50–100 years (McDowell and Sharpley, 2004; Herring and Fantel, 1993). 20–60% of the current resource base would be extracted by the year 2100 (Van Vuuren et al., 2010) with the increasing global demand for phosphorus-based fertilisers. 22% of global phosphorus demand could be satisfied by recycling human urine and faeces worldwide (Mihelcic et al., 2011).

Phosphorus recovery is a physicochemical process designed to provide near complete removal of the total phosphorus present in the influent water and convert it to a product for reuse (e.g., fertiliser). The recovery of phosphorus from wastewater (liquid phase and sewage sludge) has been implemented at full-scale installations (Ostara pearl, Crystallactor, Gifhorn) (Amann et al., 2018). Over 85% of the soluble phosphorus present in the wastewater is removed and recovered as crystals in these processes.

Phosphorus extraction from wastewaters can be from several different steps in the treatment process, including the liquid phase, dewatered sewage sludge and sewage sludge ash post thermochemical treatment (Adam et al., 2009). Also, its recovery can be induced via chemical precipitation and supercritical water oxidation.

Cranfield University established a SMARTTECH3 demonstration plant in 2017 for nutrient removal and recovery (Cranfield University, 2017). The plant has a capacity of 10 m³/d that removes ammonia and phosphorus from secondary wastewater via ion exchange which are recovered as ammonium sulphate and calcium phosphate.

2.1.2 Struvite recovery

There are several options for the recovery of resources (e.g., agricultural nutrients) from wastewater. For instance, P, N and K may be recovered as separate resources or as a complex substance such as struvite ($\text{NH}_4\text{MgPO}_4 \cdot 6\text{H}_2\text{O}$). Undesired formation of struvite can occur spontaneously in WWTPs, forming obstructive scales in pipes and pumps, causing reductions in plant efficiency and high maintenance costs. Therefore, controlled formation and recovery of struvite ahead of the main treatment plant can give benefits to the plant operation, in addition to recovering a valuable resource. Source separation of urine is an efficient method of recovering struvite since urine contributes around 80% nitrogen, 50% phosphorus, and 90% potassium to the total wastewater load (Maurer et al., 2002; Ronteltap et al., 2007). Struvite usually precipitates as white crystals (El Diwani et al., 2007). Figure 2-2 shows a schematic for struvite recovery in a fluidised bed reactor.

2.1.3 Potassium and Magnesium

Potassium (K), currently mined from potash deposits, is an essential plant macronutrient with no known substitutes. Unlike nitrogen and phosphorus, the recovery of potassium from raw water or wastewater has attracted very little interest, due to its low market value and abundant reserves that are expected to last 330 years (Batstone et al., 2014).

Methods of removing metals include physicochemical techniques such as filtration, solvent extraction, adsorption, electrodialysis and through biological and membrane processes (Barakat, 2011). Crystallisation is an established technique for the simultaneous recovery of nitrogen and phosphorus.

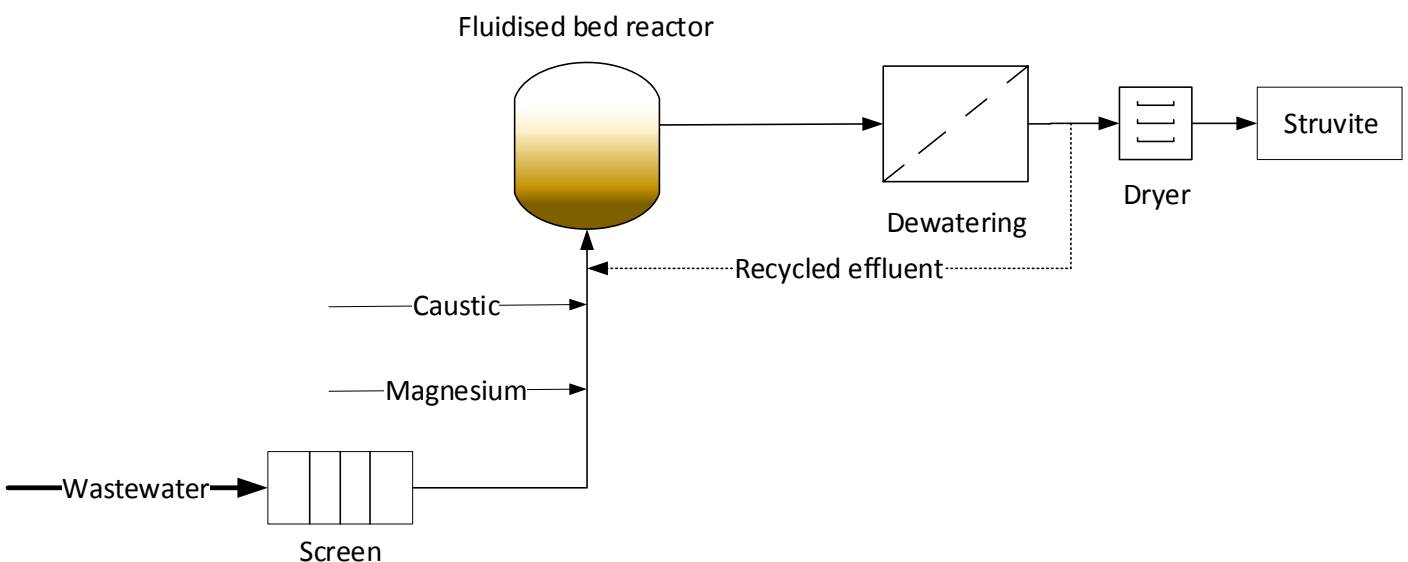

Figure 2-2 Schematic representation of Struvite recovery in a WWTP

The concentration of magnesium in many wastewaters is low in comparison to levels of ammonia-nitrogen and phosphorus but it is still recoverable as a compound. The use of magnesium in the wastewater treatment process promotes the removal of both organic materials and nutrients, particularly phosphorus and nitrogen. Quist-Jensen et al. (2016) proposed a process that integrates magnesium recovery from seawater for use in struvite recovery.

2.1.4 Calcium

Precipitated calcium carbonate (PCC), also referred to as lime pellets may be recovered from raw waters and wastewaters. Typically, PCC is produced by carbonating calcined natural calcium carbonate (limestone). The calcination process, however, generates more CO₂ than is bound during the carbonation process. An alternative technology in the Netherlands is the crystalactor based on the principle of crystallisation. The crystallisation is typically performed in a fluidised-bed reactor, in which the crystals precipitate on a seed material (e.g. sand particles). The recovered pellets may be used as a secondary raw material in the agriculture, steel and construction sectors.

2.1.5 Iron

Iron is present in low concentrations in water sources. Iron recovery is not as widely practiced as the previously described resources. In principle, iron can be recovered from waters by precipitation at alkaline pH.

2.2 Energy

The forms of energy associated with water can be classified into three groups:

- Chemically-bound energy in the organic materials (this is present in significant amounts only in wastewaters). Chemically-bound energy can be obtained from wastewaters using anaerobic digestion (AD);
- Thermal energy from the sensible heat of water and wastewaters;
- Hydrogen energy, obtained when water is split into hydrogen and oxygen using electrolysis so that hydrogen can be used as an energy vector.

2.2.1 Anaerobic digestion for methane production

Conventional anaerobic digestion converts the chemically-bound energy in wastewaters into biogas, which can be used for heat and electricity generation. In anaerobic digestion, the biodegradable fraction of the organic matter in the wastewaters or solid waste is converted into biogas by microorganisms in the absence of oxygen. The biogas consists mainly of methane (50-75% by volume) and carbon dioxide (30-55%) as well as small concentrations of other gases. Typical feedstocks for biogas production include animal waste, agricultural residue, food and drink wastes. Municipal wastewaters are typically treated using aerobic processes, rather than anaerobic digestion, which is often later used to treat the sludge produced from aerobic treatment plants. However, direct anaerobic treatment of municipal wastewaters is becoming of increasing interest at both research and commercial level, even though challenges still remain due to the slow rate of anaerobic reactions, especially at the low temperatures of municipal wastewaters in colder climates, such as in Scotland. In most cases, the methane produced from anaerobic digestion is combusted on site in CHP (combined heat and power) units, which generate power and heat. Biogas may also be cleaned up by removing carbon dioxide and other gases, leaving only pure methane, which can then be injected into the gas grid, used as vehicle fuel or used for the manufacture of other chemicals.

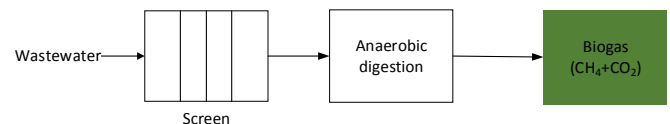

Figure 2-3 Schematic of biogas production through anaerobic digestion

2.2.2 Anaerobic digestion for hydrogen and methane production

Anaerobic digestion could also be used in a two stage process for the production of hydrogen and methane, even though this process is still at the research stage. Hydrogen is an intermediate in anaerobic digestion and in conventional processes (2.2.1) is converted to methane. However, there is a large volume of lab- and pilot-scale research focused on the use of AD for the production of hydrogen and methane, rather than methane only. Hydrogen is currently produced globally at a rate of approximately 50 million tonnes per year and is typically produced from natural gas by the steam methane reforming (SMR) process or (in smaller amounts) by water electrolysis.

2.2.3 Heat recovery

Thermal energy from water (raw water and wastewaters) can be recovered using an auxiliary circulating fluid boiling at low temperature and heat exchangers (evaporators and compressors). The heat exchanger is used to extract the sensible heat from the water, which is transferred to the heat pump. Several facilities have successfully operated based on the heat recovery from sewers technique for many years. An example is the sewage scheme that provides over 95% of the annual heat demand at a college campus in the Scottish Borders (Scottish Water, 2017). The four main components of a wastewater energy recovery system are the sewage source, the solid-liquid separation mechanism, heat exchanger, and the heat pump. Switzerland has about 50 operational heat recovery facilities (Durrenmatt, 2014). Figure 2-4 below depicts the working principle of the heat pump.

2.2.4 Electrolysis of treated wastewater to produce hydrogen

Instead of being discharged into the receiving water body (river or sea), treated wastewater could (in principle) be used to generate hydrogen using an electrolysis process. In this process, electricity would be used to provide the energy required to split water into hydrogen and oxygen, according to the reaction:

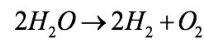

This process would only make environmental sense if the energy required for electrolysis is entirely or mainly derived from renewable sources using low-carbon processes (e.g. solar, marine or wind energy). In this case, electrolysis of treated sewage would be a process to convert electrical energy into an energy vector (hydrogen) which can be converted back to energy for transportation or heating. Water electrolysis for hydrogen production is already used by the Aberdeen City Council in a pilot project, where the hydrogen is used in fuel cells for road transportation (buses and cars) (Aberdeen City Council, 2015).

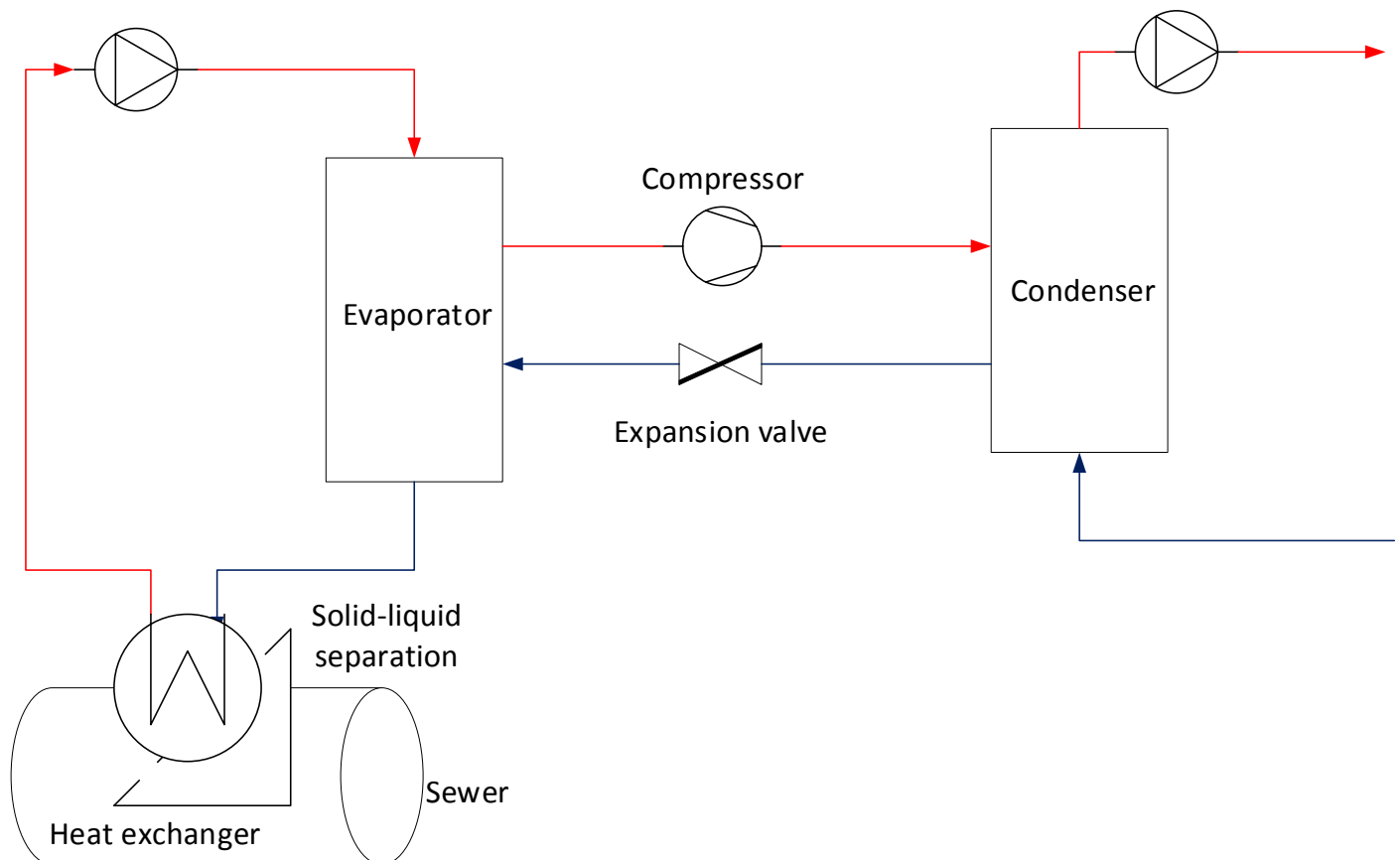

Figure 2-4 Schematic of a heat recovery system from wastewater (Adapted from Wilderer, 2010)

2.3 Organic materials

Regarding the recovery of organic materials from wastewater, there are different options, routes, and priorities. This report considers cellulose, bioplastics, biosolids, and biochar.

2.3.1 Cellulose

Cellulose is a polysaccharide found in toilet papers and can be recovered during the primary treatment of wastewater and represents a significant fraction of the wastewater COD (Chemical Oxygen Demand). Ruiken et al. (2013) demonstrated that the removal of suspended solids from the influent wastewater with sieves decreased the overall energy requirement for treatment by 40% (less aeration required). Sieves with a fine mesh <0.35mm efficiently remove cellulose fibres, removing 50-80% of the suspended solids (Rusten et al., 2016). A cellulose recovery plant near Amsterdam (Beemster Wastewater Treatment Plant) uses Salsnes Filters to separate fine cellulose fibres from the wastewater. The recovered cellulose fibres are processed into sugar and subsequently to lactic acid which serves as a base material for polylactic acid (PLA), a biodegradable type of plastic. Other applications of cellulose include dewatering filter media, carbon source, e.g., for production of fatty acids, activated carbon, stabilising additive in asphalt production (for road construction). Other benefits of cellulose recovery include reduced sludge production, minimal chemical consumption and lower release of phosphate.

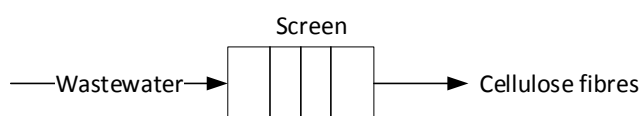

Figure 2-5 Schematic of cellulose recovery from wastewater

2.3.2 Biopolymers (bioplastics)

Bioplastics are alternatives to conventional oil-based plastics because they are derived from renewable resources. Polyhydroxyalkanoate (PHAs) is a type of biodegradable polymer synthesised by bacteria as energy and carbon storage materials (Villano et al., 2010). The first step in the PHAs recovery process is the acidogenic fermentation of the influent stream during which VFAs are produced. The generated VFAs are thereafter converted into PHAs in an aerobic process. Figure 2-6 shows a schematic of PHAs production from wastewater.

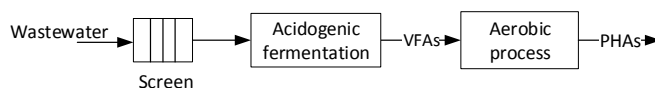

Figure 2-6 Schematic illustration of PHAs recovery from wastewater

Polylactic Acid (PLA) is primarily produced through two different processes: polymerisation and condensation (Rudnik, 2010). The most common polymerisation technique is the ring-opening polymerisation which generates larger PLA molecules from the reaction between the lactide monomer and a metal catalyst. PLA is extensively used for biomedical applications (Lasprilla et al., 2012). Other applications include domestic (such as textiles, bottles, food service ware, packaging containers), engineering (e.g., drainage and building materials) (Sin et al., 2013). A schematic of PLA production from wastewater is illustrated in Figure 2-7.

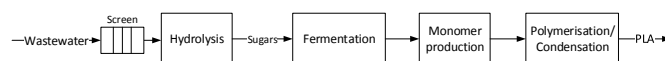

Figure 2-7 Schematic illustration of PLA recovery from wastewater

2.3.3 Biosolids

The semi-solid residue generated during the treatment of domestic wastewater is known as sewage sludge. The treatment and disposal of wastewater sludges represent significant cost factors in the treatment process. Approximately 40 million litres of liquid sludge (1% dry solids) is produced daily at the Scottish water treatment plants (Scottish water, 2006). AD is the most popular treatment for sewage sludge because of the generation of energy (OFWAT, 2015) and biosolids, which could be used as a soil conditioner or fertiliser. AD reduces the sewage sludge by 30-50%, consequently minimising the transportation costs (Nges and Liu, 2010). Biosolids are rich in organic matter and valuable agricultural nutrients like nitrogen, phosphate and potassium and other minerals.

2.3.4 Biochar

Biochar is a carbon-rich solid product formed by pyrolysis of biomass. In this report we will consider the biochar produced by pyrolysis of the biosolids produced from AD. Pyrolysis is a thermal process that occurs in the absence of oxygen (Bridgwater, 2003) where the pre-dried biomass is heated at temperatures greater than 300°C (Inguanzo et al., 2002). 90 wt.% of the dry sludge is converted into a solid char (Bonfiglioli et al., 2014). Pyrolysis of organic materials generates combustible gases and bio-oil, in addition to the biochar, which can be used for energy production (Yaman, 2004). The generated energy can support the entire plant (including drying, pyrolysis, biochar cleaning, and storage) (Wang et al., 2012). Biochar can be used as a slow-release fertiliser because of its good adsorption capacity for nitrogen and phosphorus (Sun et al., 2018). The conversion of biosolids to char eliminates the CH₄ emissions associated with the direct spread of biosolids on land since no further decomposition would occur. Biochar has excellent ability

to remove polyaromatic hydrocarbons, heavy metals, ammonium, nitrate, phosphate, and other groundwater contaminants. These contaminants are effectively retained (adsorbed) on the external surface or on the internal pores of biochar (Beesley et al., 2010).

2.4 Water

Savings in the amounts of abstracted water can be obtained by reductions in the water usage and by re-use of treated water.

Efficient implementation of water conservation has been demonstrated through the installation of water efficiency appliances (e.g., efficient shower heads, shower monitors, ultra to low water demand toilets, water-efficient washing machines). A study carried out by Lee et al. (2011) on consumer water conservation over a four-year period found that water efficiency appliances can reduce the demand for water by up to 14%.

Incentives for switching to water efficient units for the installation of water efficient technologies exist in several regions (e.g., rebate programs in California (Valley water, 2007); subsidised water efficient appliances and rebates for rainwater tanks in Sydney (Sydney water, 2010)). These are generally more acceptable to consumers in contrast to other management policies such as price increase (Randolph and Troy, 2008). Water metering at the consumer end is vital for successful implementation of water conservation through pricing measures.

Water reuse and reclamation may reduce the energy demand of the water cycle and contributes to lower emission of greenhouse gases (Wilderer, 2010). However, the energy requirement to meet adequate water quality standards for potable reuse is high. Hence, water reuse may only be relevant where a significant cost reduction is possible. Recovering energy from the wastewater can offset the increased energy requirement. Water reuse for non-potable uses includes agricultural irrigation, toilet flushing, industrial recycling (process water, cooling) and groundwater recharge (Asano, 2007). Reusing treated water preserves freshwater resources such as high-quality groundwater. Freshwater consumption is minimised by up to 40% when water is reused for toilet flushing or irrigation (Bieker et al., 2010).

3. Methodology

We collected information on the two principal water types in the water flow path where resource recovery has the most potential (i.e., wastewater and raw surface and groundwater). Raw water in this context refers to the abstracted raw water. We determined the flow rate of water involved and the concentration of each of the resources listed in Figure 2-1. Based on these characteristics, we quantified the resources and analysed their benefits. Benefit in this report was defined by the economic and environmental values. The potential environmental benefits are considered in terms of energy and CO₂ savings.

Key Assumptions

The calculations in this report are based on the total amount of resources present in Scottish waters. Our calculations do not account for the energy and resources required to recover the resources as these are technology dependent. Also, note that the market prices of the resources used in estimating the potential market value are from different years. Due to the unavailability of regional data, the resources were estimated based on a centralised perspective rather than the existing decentralised treatment systems, thus should be carefully interpreted considering that the available resources are not equally distributed across Scotland. Where possible, we applied weighting factors to account for any spatial distribution.

3.1 Resource quantification

3.1.1 Inorganic materials

The estimation of the loading (mass flow rates) of the specified resources was done through a mass balance using the water flowrate and the concentration of the resource. For wastewaters, the average concentration of each inorganic material was calculated using the weighted average of the concentration measured at the inlet of various wastewater treatment plants in Scotland. The list of the treatment plants and their inlet concentrations are reported in Appendix A. The weighted average concentration is according to Equation 3-1.

$$C_w = \frac{\sum_{i=1}^n Q_i C_i}{\sum_{i=1}^n Q_i} \quad (3-1)$$

Where

C_w = weighted average concentration of material in water (kg/m³)

n = number of sites

C_i = average wastewater concentration in the i^{th} site (kg/m^3)
 Q_i = average flow rate in the i^{th} site (m^3/y)

For raw waters, the average composition was calculated from the groundwater (average values for different types of aquifers reported in Table A-2) and surface water (Table A-2) composition, assuming 20 and 80 % of the abstracted water is from ground and surface water respectively (BGS, 2015).

The loadings of the inorganic materials in raw waters and wastewaters were calculated according to the Equation (3-2):

$$\text{Material mass loading (t/y)} = C_w \times Q_w \quad (3-2)$$

Where C_w = concentration of material in the water and Q_w = total flow rate of the water (raw water or wastewater)

3.1.2 Organic materials

3.1.2.1 Cellulose

The amount of toilet paper (cellulose) represents 20 - 35% of the suspended solids in wastewaters (Ruiken et al., 2013; Honda et al., 2002). The cellulose load (in tonnes per year, t/y) in wastewaters in Scotland was calculated with Equation (3-3):

$$\text{Cellulose generation (t/y)} = C_{SS} \times Q_w \times f_c \quad (3-3)$$

Where C_{SS} is the suspended solids concentration, calculated as the weighted average of the suspended solids concentration at the inlet of wastewater treatment plants (Table A-1), and f_c represents the fraction of cellulose in the total suspended solids the influent wastewater = 0.2 g cellulose/g suspended solids

3.1.2.2 Biopolymers

PHAs (Polyhydroxyalkanoates)

Conversion of the wastewater COD to PHAs requires the conversion of the COD to acetic acid (or to other organic acids) and then the conversion of acetic acid into PHAs. The potential PHAs production from wastewaters was calculated according to Equation (3-4):

$$\text{PHAs production (t/y)} = C_{COD} \times Q_w \times \text{Yield}_{Ac} \times \text{Yield}_{PHA} \quad (3-4)$$

Where Yield_{Ac} = 0.315 g acetic acid/g COD (this yield corresponds to 50% of the maximum theoretical yield of acetic acid from glucose) and Yield_{PHA} = 0.32 g PHA/g Ac (Karlsson, 2010).

PLA (poly-lactic acid)

Conversion of the wastewater COD to PLA requires conversion of the COD to lactic acid and then polymerisation of lactic acid. The potential PLA production (in tonnes per year, t/y) from wastewater was calculated according to Equation (3-5):

$$\text{PLA production (t/y)} = C_{COD} \times Q_w \times \text{Yield}_{LA} \times \text{Yield}_{PLA} \quad (3-5)$$

Where Yield_{LA} = 0.465 g LA/g COD (50% of the maximum theoretical yield of lactic acid from glucose) and Yield_{PLA} = 0.51 g PLA/g LA (Orozco et al., 2014)

3.1.2.3 Biosolids

Biosolids represent the total organic solids produced by anaerobic digestion. It was assumed that the generation of biosolids corresponds to 0.16 kg (as dry matter) per m^3 of wastewater (our own calculations using data from Scottish Water (2006) (Equation (3-6)).

$$\text{Biosolids generation (t/y)} = Q_w \times f_{bs} \quad (3-6)$$

Where f_{bs} is equal to 0.00016 t (DM)/ m^3 .

3.1.2.4 Biochar

Biochar represents the remaining solids after pyrolysis of the biosolids (which were calculated in the previous section). The amount of biochar produced was quantified by assuming that biochar is 10% of the mass of the biosolids fed to the pyrolysis process (BFT, 2018) (Equation (3-7)).

$$\text{Biochar generation (t/y)} = \text{Biosolids generation} \times f_{bc} \quad (3-7)$$

Where the biosolids recovered as biochar generation was calculated according to Equation (3-6) and f_{bc} = 0.10.

3.1.2 Energy

3.1.2.5 Anaerobic digestion for methane or methane and hydrogen production

The methane production from anaerobic digestion was calculated using the COD of the wastewater. The COD represents the amount of oxygen required to completely oxidise the organic matter to carbon dioxide and water and is proportional to the total concentration of organic species. The maximum theoretical conversion yield of the biodegradable COD to methane is 100% (Dionisi, 2017). This is in principle not practicable due to the inevitable production of microorganisms which will decrease the yield. Therefore, the potential methane production was calculated (Equation 3-8) assuming a methane generation yield of 80%

COD/COD, i.e., 0.8 kg of methane as COD is obtained per kg of COD of the wastewater. This corresponds to a methane yield of 0.2 kg of methane per kg of COD in the wastewater (1 kg of methane corresponds to 4 kg of COD).

$$\text{Methane generation (t/y)} = C_{\text{COD}} \times Q_w \times \text{Yield}_{\text{CH}_4} \quad (3-8)$$

Where C_{COD} = Average COD concentration in the wastewater (kg/m³), $\text{Yield}_{\text{CH}_4} = 0.2 \text{ kg CH}_4/\text{kg COD}$, and Q_w is the already defined total flow rate of wastewaters in Scotland.

Alternatively, a two-stage process that produces both hydrogen and methane can be considered. The hydrogen and methane production with this process was calculated according to Equation (3-9)

$$\begin{aligned} \text{Hydrogen production (t/y)} &= C_{\text{COD}} \times Q_w \times \text{Yield}_{\text{H}_2} \\ \text{Methane production (t/y)} &= C_{\text{COD}} \times Q_w \times \text{Yield}_{\text{CH}_4} \end{aligned} \quad (3-9)$$

Where $\text{Yield}_{\text{H}_2} = 0.021 \text{ g H}_2/\text{g COD}$ wastewater (this corresponds to 50% of the theoretical maximum hydrogen yield from glucose) and $\text{Yield}_{\text{CH}_4} = 0.158 \text{ g CH}_4/\text{g COD}$ wastewater (this assumes that 80% of the total COD of the wastewater is converted to hydrogen and methane).

3.1.2.2 Heat pumps

The amount of recoverable thermal energy (E) is directly proportional to the flowrate of the sewage and the change in sewage temperature and can be calculated by:

$$E \text{ (MW)} = \rho \times Q_w \times c_p \times \Delta T \quad (3-10)$$

Where c_p is the specific heat capacity of water (4.18 kJ/kg°C), ΔT the change in sewage temperature (°C) and Q_w , the volumetric flow rate of water (m³/d). A drop in water temperature of approximately 6-10 °C is what might be available for heat energy (McCarthy, 2011). A temperature change of 5 °C was assumed in estimating the recoverable thermal energy (Neugebauer et al., 2015).

3.1.3.4 Anaerobic digestion of solid waste

The potential methane production from the anaerobic digestion of solid waste generated in Scotland was estimated according to Equation (3-11).

$$\text{Methane (t/y)} = \text{Total feedstock (DM)} \times \text{COD factor} \times \text{Yield}_{\text{CH}_4} \quad (3-11)$$

Where the total feedstock is reported in Table B-1, the COD factor was assumed to be equal to 1.21 kg COD/kg dry matter, based on an assumed composition of the organic

waste (Dionisi et al., 2018) and $\text{Yield}_{\text{CH}_4} = 0.2 \text{ kg CH}_4/\text{kg COD}$.

3.1.3 Hydrogen from treated water through electrolysis

From the stoichiometric equation of water electrolysis, one mole of H₂O produces two moles of H₂. The amount of hydrogen obtainable from 1 litre of water can be estimated using the molecular weights of water, hydrogen, and oxygen. Hydrogen production from water corresponds to 111.8 kg H₂ per m³ of water.

$$\text{Hydrogen production (t/y)} = Q_w \times f_{\text{H}_2} \quad (3-12)$$

Where f_{H_2} is equal to 0.119 t H₂/m³ water.

3.2 Benefits

Benefits evaluation in this report was based on energy and CO₂ savings (assessed at market value) associated with the resources potentially available in raw waters and wastewaters. The energy and CO₂ savings are those associated with the production of the resource from conventional processes. The market value of the energy resources is related to their intended purpose.

The equation used to calculate the energy savings associated with each resource is:

$$\text{Energy savings (GWh/y)} = E_i \times \text{Material loading} \quad (3-13)$$

Where E_i is the energy required for production (kWh/kg) of the resource in conventional processes.

The CO₂ savings were calculated according to Equation (3-14). The emission factor (t CO₂/GWh) is based on the primary fuel sources combusted during a process.

$$\text{CO}_2 \text{ savings (t CO}_2/\text{y)} = E_i \times \text{Emission factor} \quad (3-14)$$

For anaerobic digestion, in addition to the benefits due to methane production, we also calculated the additional benefits due to the savings in aeration costs, energy, and CO₂ emissions, considering that anaerobic digestion replaces the conventional aerobic treatment. The average energy consumption for aeration in aerobic wastewater treatment is estimated at 0.3 kWh/m³ (McCarthy et al., 2011).

$$\text{Aeration savings (E/y)} = Q_w \times E_{\text{Aeration}} \times \text{Cost of electrical energy} \quad (3-15)$$

Where Q_w is the flowrate of the wastewater (m³/y), and E_{Aeration} is the energy consumed for aeration = 0.3 kWh/m³.

The savings in CO₂ emissions due to using anaerobic digestion instead of aerobic treatment were calculated assuming that 0.25 kgCO₂ are generated per kWh of electricity production.

Therefore, the total energy savings for anaerobic treatment for biogas and hydrogen recovery reported in the “results” section was calculated as the sum of the energy gained from AD and the aeration savings from the conventional aerobic treatment.

Table 3-1 Parameters used to estimate the potential benefits of the inorganic materials

Resource	Market value (£/kg)	Energy consumption to produce the resource with conventional processes (kWh/kg)	CO ₂ emissions to produce the resource with conventional processes (kg CO ₂ /kg)
N in fertiliser	0.78 ^a	19.30 ^b	6.80 ^c
P in P ₂ O ₅	1.36 ^a	4.93 ^b	2.77 ^c
K in K ₂ O	0.53 ^a	2.06 ^b	0.61 ^c
Ca in CaCO ₃	0.56 ^d	0.85 ^e	0.24 ^e
Mg in MgO	0.71 ^f	4.15 ^g	3.07 ^g
Fe in FeSO ₄ ·7H ₂ O	0.68 ^h	0.48 ^e	0.1 ⁱ

^a WRAP (2018)

^b Gellings and Parmenter (2004)

^c Zero Waste Scotland (2016)

^d Average price for uncoated CaCO₃ (Industrial Minerals prices, 2016)

^e European Commission (2007)

^f FinancialBuzz (2018)

^g European Commission (2010)

^h ICIS (2005)

ⁱ Based on the sulphate route of titanium dioxide manufacture. There is no direct CO₂ emission associated with the production of ferrous sulphate (copperas) in this process. Therefore the CO₂ emission was calculated from the energy consumption related to copperas manufacture assuming that 90% gas consumption and 10% electricity consumption resulting in a weighted average of 0.21 kg CO₂/kWh. CO₂ emission factor for electricity: 0.25 kg CO₂/kWh (energy mix for electricity in the UK). CO₂ emission factor for natural gas: 0.2 kg CO₂/kWh (DEFRA, 2017).

Table 3-2 Parameters used to estimate the potential benefits of the organic materials

Resource	Market value (£/kg)	Energy consumption to produce the resource with conventional processes (kWh/kg)	CO ₂ emissions to produce the resource with conventional processes (kg CO ₂ /kg)
Cellulose	0.28 ^a	3.34 ^b	0.67 ^c
PHAs	4.83 ^d	20.38 ^e	1.69 ^e
PLA	1.78 ^f	23.28 ^g	2.30 ^g
Biosolids ^h	0.06	0.0008	0.29
Biochar	1.00 ⁱ	3.25 ^j	0.64 ^k

^a van Leeuwen et al., 2018

^b Energy consumed in the wood pulping process (European Commission, 1999)

^c Energy consumption (kWh/kg) X GHG emission factor (kg CO₂/kWh natural gas)

^d European Commission, 2015

^e Plastics Europe, 2005, values for polypropylene, because PHAs has comparable properties and would replace its use.

^f Liew et al., 2014, values for polyethylene terephthalate (PET), because PLA has comparable properties and would replace its use.

^g Borodin et al., 2015

^h Market value, energy requirements and CO₂ emissions are calculated based on the available nutrients concentrations of the biosolids which assumes a 35 kg N/tonne, 45 kg P₂O₅/tonne, 4 kg K₂O /tonne (DRM, 2015). However, Zero Waste Scotland (2010) reported lower anticipated digestate value at around £5 per tonne because the farmers lack in-depth knowledge about its properties and value.

ⁱ Value from BBF, 2017

^j heating value of biochar (Agar et al., 2018)

^k based on the calorific value of biochar and on the CO₂ emissions associated with the natural gas (methane) which would be replaced by the biochar

Table 3-3 Parameters used to estimate the potential benefits of energy

Resource	Market value (£/kg)	Energy consumption to produce the resource with conventional processes (kWh/kg)	CO ₂ emissions to produce the resource with conventional processes (kg CO ₂ /kg)
Methane	0.50 ^a	13.75 ^b	2.75 ^b
Hydrogen ^c	4.50	51.09	12.20
Heat ^d	0.036	-	0.20 ^e

^a The market price for methane was estimated based on a market value of heat energy of £0.036/kWh and with a calorific value of methane of 50 MJ/kg

^b The energy consumption was calculated from the calorific value (50 MJ/kg) considering that the production of methane from wastewater would offset the use of natural gas as energy source. CO₂ emission according to the stoichiometry of methane combustion is 2.75 kg CO₂/kg methane.

^c Price is an estimation of the market value of hydrogen from the refuelling stations in Aberdeen (personal communication). Energy consumption is the weighted average of energy required to produce hydrogen by Steam Methane Reforming (SMR) of natural gas (NREL, 2001) and electrolysis (Renewable energy focus, 2009), assuming that SMR accounts for 96% of hydrogen production and water electrolysis accounts for 4%. The same approach was used to estimate the CO₂ emission based on the data from NREL (2001).

^d Value in £/kwh. Average market price of heat for domestic use in the UK.

^e Value in kg CO₂/kWh assuming that heat from heat pumps replaces natural gas (methane), assuming a calorific value of methane of 50 MJ/kg and CO₂ emissions of 2.75 kg CO₂/kg methane

3.3 Technology Readiness Level

The relative benefits of the considered resources are evaluated graphically as grids against the readiness levels of the recovery technologies. Figure 3-1 illustrates a scale of readiness levels that was used in assessing the status of the resources. Technology readiness level is influenced by the intended purpose of the recovered material.

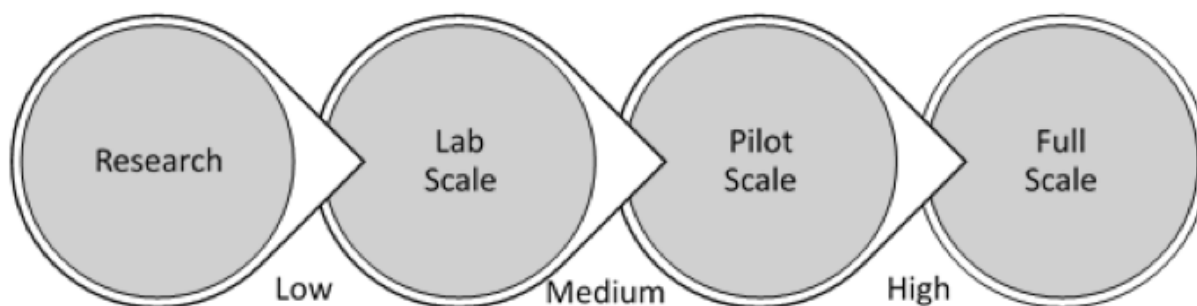

Figure 3-1 Outline of recovery technology readiness levels

Table 3-2. Summary of the TRL for the various technologies considered in this report

Technology	TRL	Comment
N recovery-Precipitation as struvite or in other forms, ion exchange or others	Medium-High	Already used in some countries
P recovery-Precipitation as struvite or in other forms	Medium-High	Already used in some countries
Ca recovery- Precipitations as CaCO ₃ or in other forms	Medium-High	Already used in some countries
Mg recovery-Precipitation as struvite of in other forms	Medium	Already used in some countries
K recovery-Precipitation	Medium	Already used in some countries
Fe recovery-Precipitation	Low-Medium	Limited commercial experience
Anaerobic digestion for methane production	Medium-High	Used commercially for solid waste, use with municipal wastewaters much more limited
Anaerobic digestion for hydrogen methane production	Low-Medium	At research and pilot stage, especially with solid waste, limited investigation for municipal wastewaters
Heat pumps	Medium-High	Some limited commercial experience
Electrolysis of treated wastewater for hydrogen production	Low-Medium	Used at small scale but not with wastewaters
Bioplastics (PHAs and PLA)	Low-Medium	Produced commercially at limited scale but not from organic waste, very limited research experience with municipal wastewaters
Biosolids	High	Already commercially used at large scale

4. Results

The first step in our analysis was the calculation of the average composition of raw waters and wastewaters in Scotland and their total flow rates (Table 4-1 and Figure 4-1). Figure 4-1 shows that a significant fraction of the total abstracted water is lost as leakages before it reaches the final users. The wastewater flow rate considered in this report comes from the domestic water and water run offs. Overall, the concentrations of mineral elements are more abundant in wastewaters than in raw waters, but flow rates of raw waters are higher than for wastewater.

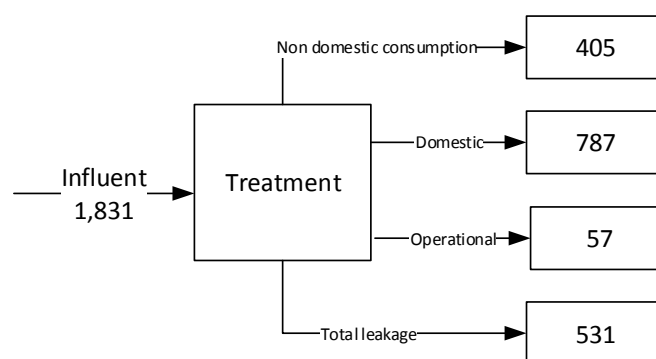

Figure 4-1 Water distribution for the 2015/16 period(National statistics, 2016). Figures in ML/d.

Table 4-1 Average characteristics of raw water and wastewater in Scotland

Parameter	Raw water	Wastewater ^a	
		Value	Unit
Total flowrate in Scotland, Q	1,831 ^b	930	ML/d
Nitrogen, N	1.3	19.4	mg/l
Phosphorus, P	0.06	3.7	mg/l
Potassium, K	2.07	14.3	mg/l
Calcium, Ca	25.2	45.5	mg/l
Magnesium, Mg	7.1	11.4	mg/l
Iron, Fe	0.5	2.5	mg/l
COD	-	370	mg/l
Suspended solids, SS	-	487	mg/l
Temperature	-	12.7	°C

^a Data from 41 sites across Scotland averaged between the period 2016-2017

^b 2015/16 total abstracted water (National statistics, 2016)

Using the information presented in Table 4-1, Table 4-2 reports the total mass flow rates of each resource in raw water and wastewater alongside the potential benefits (market value, energy, and CO₂ emissions savings) assuming 100% recovery of the resources (Table 4-2). Figure 4-2 compares the potential benefits of recovering the various resources graphically.

As far as the inorganic elements are concerned, calcium (over 15,000 t/y for each) is the most abundant resource both in raw waters and in wastewaters. Magnesium's flow is also similar in raw waters and wastewaters (about 4,000 t/y), but the mass flows of all the other elements are higher for wastewaters than for raw waters. In terms of market value of the inorganic elements, calcium has the highest value (£8-9 M/y) because of its mass flow is the largest, followed by nitrogen in wastewaters (£5 M/y). In terms of maximum potential savings in energy and CO₂ emissions, recovering nitrogen from wastewaters has the highest impact among inorganic elements (127 GWh/y and 44 kt CO₂/y). This is due to the high energy consumptions and CO₂ emissions associated with the current production processes for nitrogen to be used in fertilisers. In terms of the technology readiness level (TRL), in many cases, these inorganics can be recovered with relatively simple pH balancing processes, even though a major issue is obtaining them with the desired purity.

The recovery of organic materials (cellulose, PHAs, PLA, biosolids, and biochar) from wastewaters is, in general, more important, in terms of quantities, market value, energy, and CO₂ savings than the recovery of inorganic materials. The quantities of organic materials are in the range of 2-30 kt/y. The most significant market value and potential energy and CO₂ savings are for PHAs and PLA. These bioplastics have substantial unit market value because they are renewable and biodegradable plastics (although the biodegradation of PHAs is usually much faster than of PLA), and this explains the substantial amount potentially obtainable from the recovery of these materials. The TRL is different for the various organic materials. The recovery of biosolids is well established, but biosolids have the lowest market value and energy/CO₂ savings. Recovery of PHAs and PLA from wastewaters is not currently done, and it would require some research and adaptation of the current processes to produce these plastics. As far as cellulose recovery from wastewaters is concerned, the technology is not yet mature and would require additional research and development.

Recovery of heat via heat pumps gives the most significant potential benefits from raw waters and wastewaters (excluding hydrogen generation via electrolysis of treated wastewaters, discussed later) in terms of market value,

energy, and CO₂ emissions savings. The reason for this is that heat pumps utilise the total sensible heat of waters, while recovery of materials only uses the inorganic elements or the organic materials present in waters, which account for a minor fraction of the total mass of the stream. The market value of the total potential heat generated by heat pumps is £70M/y for wastewaters and £140 M/y for raw waters (due to the larger total flow rate of raw waters), with potential energy savings in the range 2,000-4,000 GWh/y and potential CO₂ savings in the range 400-800 kt/y.

Recovery of methane from the organic matter in wastewaters via AD is another valuable opportunity for resource recovery. Considering the additional savings due to avoiding aeration costs, the potential market value of AD is in the region of £22 M/y, with potential energy savings of 450 GWh/y and CO₂ savings close to 100 kt/y. AD is a widely used technology for the treatment of solid organic waste. However, it is not widely used for the treatment of municipal wastewaters. While more research and development is needed for exploiting the full potential of AD for municipal wastewaters, we think this technology is not far off for commercial success. A more innovative type of AD is its use to produce hydrogen and methane, rather than methane only. In this case, the benefits would be more significant than for conventional AD to just methane, especially considering the large market value of hydrogen. Nevertheless, this technology needs more research.

AD can generate much more methane, and therefore energy, if the feedstock is extended to include other organic waste in addition to wastewaters. With the rate of organic waste generation in Scotland, AD could potentially generate over 1 Mt CH₄/year, with a value of over £500 M/y, over 15,000 GWh/y and CO₂ savings of over 3,000 kt/y. The AD technology for solid organic waste is relatively established. However, processes need to be optimised depending on the type of feedstock to maximise the methane yield.

In the case of hydrogen production from treated wastewater via electrolysis, the amounts of hydrogen potentially recoverable are huge, in the region of 38 Mt/year. Although the market value of the produced hydrogen could be very high, water electrolysis is very energy intensive and at present hydrogen production using this technology is not carried out at large scale. It is important to note that water electrolysis is not likely to give any energy savings in the production of hydrogen compared to the conventional process of hydrogen production from steam methane reforming, because water electrolysis is an energy-intensive process due to the need to split water into hydrogen and oxygen. Therefore the energy savings for this resource are not reported in Table 4-2 and in Figure 4-2. However, the

process is likely to give considerable carbon dioxide savings if the electricity for hydrogen generation is derived from low-carbon processes (e.g. wind, marine and solar energy).

Table 4-2. Calculated potential resources and benefits. The values reported in this table correspond to the potential resources obtainable assuming 100% recovery (see Methodology in Section 3). The market values, potential energy and CO₂ savings do not consider the costs, energy requirements and CO₂ emissions of the recovery processes.

Resource	Potential resource available (t/y)	Market value of the resource (£'000)	Potential energy saving (GWh/y)	Potential CO ₂ saving (kt CO ₂ /y)
Inorganic materials from wastewater				
Nitrogen in fertilisers	6,578	5,131	126.9	44.7
P in P ₂ O ₅	1,262	1,717	6.2	3.5
K in K ₂ O	4,864	2,595	10.0	2.9
Ca in CaCO ₃	15,423	8,691	13.1	3.7
Mg in MgO	3,859	2,175	16.0	11.8
Fe in FeSO ₄	859	586	0.4	0.1
Inorganic materials from raw water				
Nitrogen in fertilisers	858	669	17	5.8
P in P ₂ O ₅	40	21	0.2	0.1
K in K ₂ O	1,383	738	3.0	0.8
Ca in CaCO ₃	16,844	9,433	14	4.1
Mg in MgO	4,753	3,389	20	14.6
Fe in FeSO ₄	314	214	0.1	0.03
Organic materials from wastewater				
Cellulose	33,069	9,259	111	22.2
PHAs	12,642	61,059	258	21.4
PLA	30,061	53,509	700	69.1
Biosolids	54,285	3,019	42.3	16.0
Biochar	5,429	5,429	17.6 ¹	3.5
Anaerobic digestion process for methane production				
Methane	25,083	12,541	348	69.0
Additional savings from AD by avoiding aerobic treatment	N/A	10,178	102	25.4
Total resource from AD for methane production	25,083	22,720	450	94.4

Table 4-2. Calculated potential resources and benefits. The values reported in this table correspond to the potential resources obtainable assuming 100% recovery (see Methodology in Section 3). The market values, potential energy and CO₂ savings do not consider the costs, energy requirements and CO₂ emissions of the recovery processes.

Resource	Potential resource available (t/y)	Market value of the resource (£'000)	Potential energy saving (GWh/y)	Potential CO ₂ saving (kt CO ₂ /y)
Anaerobic digestion process for hydrogen and methane production				
Hydrogen	2,634	11,852	135	32.1
Methane	19,815	9,908	273	54.5
Additional savings from AD by avoiding aerobic treatment	N/A	10,178	102	25.4
Total resource from AD for hydrogen and methane	22,449	31,938	509	112
Heat pumps from wastewaters	-	71,012	1,973	395
Heat pumps from raw waters	-	139,879	3,886	777
Anaerobic digestion of other organic waste to methane				
Methane	1,118,654	553,734	15,381	3,076
Hydrogen from treated wastewater through electrolysis				
Hydrogen	37,931,759	170,692,916	-	462,767

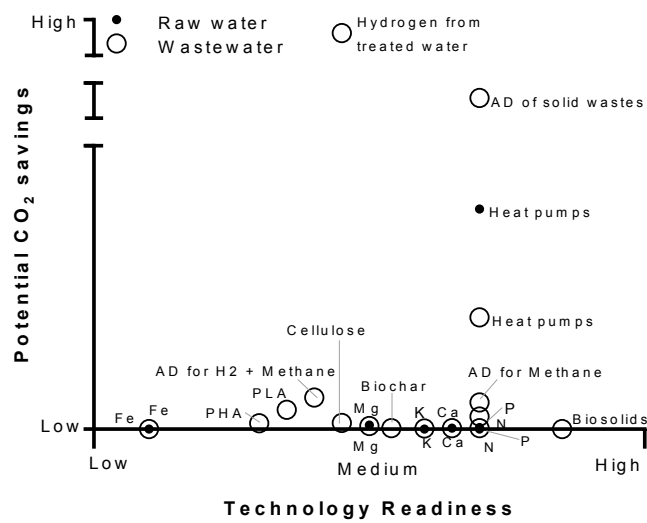
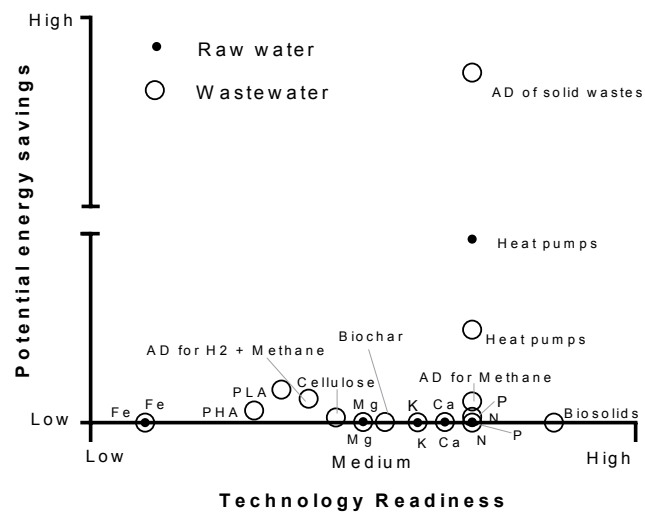
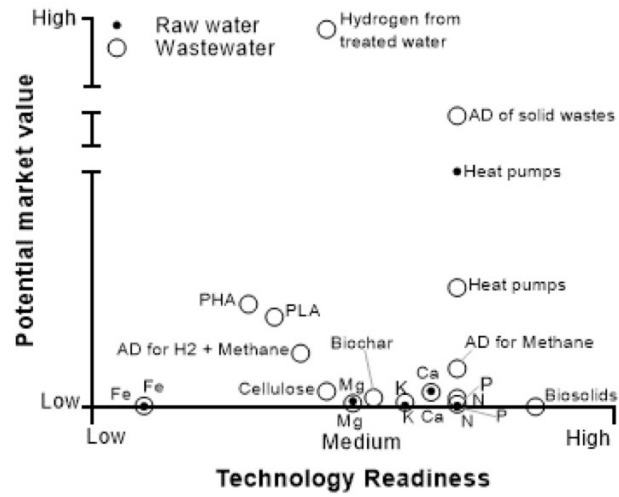

Figure 4-2 Graphical representation of the estimated benefits in the abstracted raw water and wastewater against the technology readiness of the recovery process

5. Discussion

5.1 Comparison of Potential vs Current Resource Recovery Practices

In general, the actual recovery of resources from waters in Scotland is much lower than the maximum potential calculated in this report. To the best of our knowledge, inorganic elements and organic materials (with the exception of biosolids from AD of sewage sludge) are not currently recovered from waters in Scotland. Energy, on the other hand, is being generated from the anaerobic digestion of sewage sludge. The current energy recovery via anaerobic digestion of sewage sludge is in the order of 25 GWh/y (source: Scottish Water), while our study indicates that AD has the potential to generate 348 GWh/y of energy. One of the reasons for this difference is that currently AD is only used for the energy recovery from the sludge from wastewater treatment plants, which only contains a small fraction of the organic matter originally present in the wastewater because most of the COD is degraded aerobically. Instead, our study assumes the digestion of all the organic matter in the wastewater, without any aerobic treatment. The use of heat pumps for heat recovery from raw water and wastewater in Scotland is also very limited.

5.2 Impact of Recovery on Materials and Energy Requirements

As far as materials consumption is concerned, Figure 5-1 compares the current needs in Scotland of N, P, and K with the amounts potentially available in raw waters and wastewaters. The quantities of these elements available in Scottish waters correspond to 2-5% of the requirements in Scotland. There is scope to capture N, P and K (among water, sediment, and other resources) associated with runoff from agricultural lands via nature-based solutions or hard engineering approaches at the source. This would allow for capturing high concentrations locally, but small total quantities (as a proportion of the total budget) at a time. Perhaps more important is the potential impact of energy recovery from wastewaters and from other sources of organic waste. Figure 5-2 compares the total heat demand in Scotland with the heat energy potentially recoverable using heat pumps or anaerobic digestion of wastewaters and other organic waste. A significant fraction, approximately 20%, of the heat demand in Scotland could be supplied by these resources. Considering that the vast majority of heat demand in Scotland is currently provided by natural gas, the

use of water resources would give a significant contribution in decarbonising the energy supply and in providing a renewable source of heat.

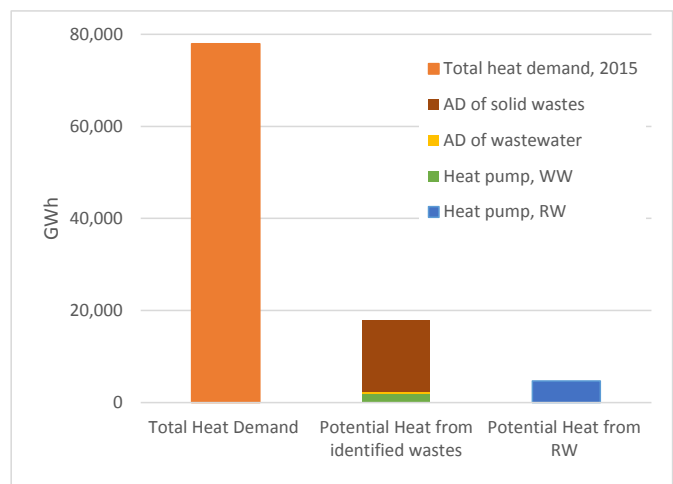
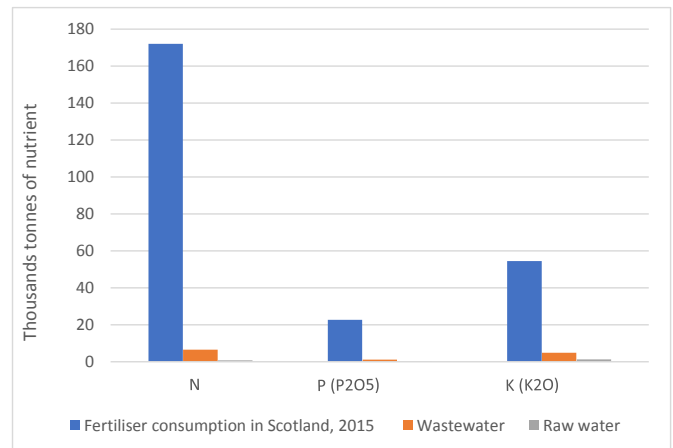

Figure 5-2 Total heat energy demand in Scotland in 2015 compared to the potential heat energy savings in recovering resources from raw and wastewater. The chart is based on the data presented in Table 4-2.

Figure 5-3 compares the CO₂ emissions in Scotland with the potential savings associated with resource recovery from raw waters and wastewaters. Recovery of these resources would correspond to a maximum potential reduction of CO₂ emissions of approximately 10%, which is a significant impact. However, the CO₂ emissions from the resource recovery technologies themselves need to be considered.

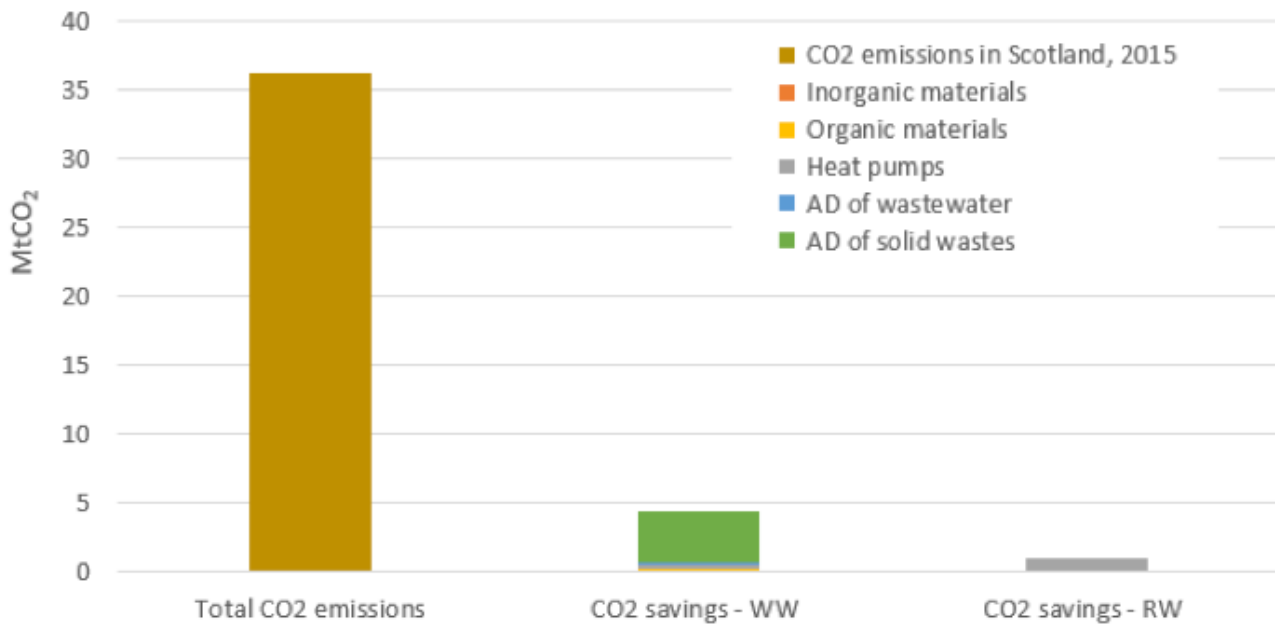

Figure 5-3 Total CO₂ emissions in Scotland in 2015 compared to the potential CO₂ savings in recovering resources from raw and wastewater. The chart is based on the data presented in Table 4-2.

Regarding the production of hydrogen and plastics, i.e., PHAs and PLA, from wastewaters, it is appropriate to carry out the analysis on a global scale rather than on a regional (Scotland) scale, because hydrogen and plastics are not produced (except for minor quantities) in Scotland but are traded globally. Globally, hydrogen is produced at a rate of approximately 50 million tonnes per year, while plastics production is in the order of 350 million tonnes per year. The rate of hydrogen and plastics potentially recoverable from Scottish wastewaters can be scaled-up on a population basis, assuming that the generation of COD in municipal wastewaters is the same, per capita, across different countries. Since Scotland's population is 1/1,381th of the global population (population data for Scotland and the world in 2017), using this scaling factor we can calculate that the potential production of hydrogen from wastewaters is in the order of 3.6 Mt/y, while the PHAs and PLA potential production is in the order of 17.6 Mt/y and 40 Mt/y. These potential production rates are significant and correspond to approximately 7% and 5-11% of the global production of hydrogen and plastics, respectively.

6. Conclusions

- The most significant potential, with a relatively high technology readiness level (TRL), for resource recovery from raw waters and municipal wastewaters lies in the recovery of heat via heat pumps. Considering

raw waters and wastewaters together, heat pumps could potentially generate up to 5,800 GWh/y, with a potential economic value of over £200 M/y and savings in CO₂ emissions of up to 1,000 kt/y;

- The use of anaerobic digestion to convert the organic matter in wastewaters into methane also has a high potential. Up to 25,000 t CH₄/y could be generated, and, including the savings in aeration energy, the total market value would be over £20 M/y, with energy savings of up to 450 GWh/y and savings in CO₂ emissions close to 100 kt/y. The value of anaerobic digestion of wastewaters could be enhanced by combining hydrogen and methane production, but this technology is at a lower TRL;
- Although at a lower technology readiness level, the use of the organic matter in wastewater to produce bioplastics have a significant potential regarding quantities of plastics potentially recoverable and market value;
- Recovery of inorganic elements from waters and wastewaters would give comparatively lower benefits, with market values of up to £10 M/y (for Ca recovery from raw waters), energy and CO₂ savings of up to 127 GWh/y and 45 kt/y, respectively (for N recovery from wastewaters);
- Considering solid organic waste (e.g., food and agricultural waste), the potential benefits of resource recovery from anaerobic digestion are more significant than just using wastewaters. Up to 1 Mt CH₄/y could be produced, with a market value of over £500 M/y,

energy savings of 15,000 GWh/y and savings in CO₂ emissions of up to 3,000 kt/y;

- The total heat generation from wastewaters and solid organic waste (including both heat pumps and anaerobic digestion) could provide up to 20% of the heat demand in Scotland and could reduce the total CO₂ emissions in Scotland by approximately 10%. Recovery of N and P from wastewaters could provide up to 5% of the N and P currently used as fertilisers in Scotland;
- Very large amounts of hydrogen (over 37 Mt/y) could potentially be produced by the electrolysis of the treated wastewaters. This technology could give potentially very large savings in carbon dioxide emissions compared to current processes for hydrogen production (steam methane reforming), if the electricity is obtained from zero- or low-carbon processes. However, the TRL of this technology is relatively low;
- For the recovery project to proceed past a theoretical stage, it is of critical importance to conduct a technical and financial feasibility study.

References

- Aberdeen City Council (2015). Aberdeen opens UK's largest hydrogen production, fueling station for expanding bus fleet, *Fuel Cells Bulletin*, 7, 12-13.
- Adam, C., Peplinski, B., Michaelis, M., Kley, G. and Simon, F.G. (2009). Thermochemical treatment of sewage sludge ashes for phosphorus recovery. *Waste management*, 29(3), 1122-1128.
- Agar, D. A., Kwapinska, M., and Leahy, J. J. (2018). Pyrolysis of wastewater sludge and composted organic fines from municipal solid waste: laboratory reactor characterisation and product distribution. *Environmental Science and Pollution Research*, 1-9.
- Amann, A., Zoboli, O., Krampe, J., Rechberger, H., Zessner, M. and Egle, L. (2018). Environmental impacts of phosphorus recovery from municipal wastewater. *Resources, Conservation and Recycling*, 130, 127-139.
- Aquatec Maxcon (2012). Crystalactor. Available at <http://www.aquatecmaxcon.com.au/technologies/industrial-processes/crystalactor> (accessed March 2018).
- Barakat, M. A. (2011). New trends in removing heavy metals from industrial wastewater. *Arabian Journal of Chemistry*, 4(4), 361-377.
- Batstone, D. J.; Hülsen, T.; Mehta, C. M.; Keller, J. (2014). Platforms for energy and nutrient recovery from domestic wastewater: A review. *Chemosphere*, 140, 2–11
- BBF (British Biochar Foundation) (2017). Biochar FAQ's. Available at http://www.britishbiocharfoundation.org/?page_id=52 (accessed April 7, 2018)
- Beesley, L., Moreno-Jiménez, E., and Gomez-Eyles, J. L. (2010). Effects of biochar and greenwaste compost amendments on mobility, bioavailability and toxicity of inorganic and organic contaminants in a multi-element polluted soil. *Environmental pollution*, 158(6), 2282-2287.
- BFT (BIOFORCETECH) (2018). Cost effective, constant, and reliable biochar production from organic waste and biosolids. Available at <http://bioforcetech.com/process.html> (accessed April 7, 2018)
- BGS (2015). Scotland's aquifers and groundwater bodies Available at <http://nora.nerc.ac.uk/id/eprint/511413/1/OR15028.pdf> (accessed March 2018).
- Bieker, S., Cornel, P., and Wagner, M. (2010). Semicentralised supply and treatment systems: integrated infrastructure solutions for fast growing urban areas. *Water science and technology*, 61(11), 2905-2913.
- Bonfiglioli, L., Bianchini, A., Pellegrini, M., and Saccani, C. (2014). Sewage sludge: characteristics and recovery options.
- Borodin, Y. V., Aliferova, T. E., and Ncube, A. (2015). Waste management through life cycle assessment of products. In *IOP Conference Series: Materials Science and Engineering* (Vol. 81, No. 1, p. 012085). IOP Publishing.
- Brewster, E. T., Mehta, C. M., Radjenovic, J., and Batstone, D. J. (2016). A mechanistic model for electrochemical nutrient recovery systems. *Water research*, 94, 176-186.
- Bridgwater, A. V. (2003). Renewable fuels and chemicals by thermal processing of biomass. *Chemical Engineering Journal*, 91(2-3), 87-102.
- Cranfield University (2017). New plant technology to remove and recover nutrients from wastewater. Available at <https://www.cranfield.ac.uk/press/news-2017/new-plant-technology-to-remove-and-recover-nutrients-from-wastewater> (accessed March 2018).
- DEFRA (2017). Greenhouse gas reporting: conversion factors 2017. Available at <https://www.gov.uk/government/publications/greenhouse-gas-reporting-conversion-factors-2017> (accessed February 2018).
- Dionisi, D. (2017). *Biological Wastewater Treatment Processes – Mass and heat balances*. CRC press, Boca Raton, FL, USA.
- Dionisi, D., Bolaji, I., Nabbanda, D. & Silva, IMO (2018). Calculation of the potential production of methane and chemicals using anaerobic digestion. *Biofuels, Bioproducts and Biorefining*, in press.
- DRM (2015). Granular biosolid fertiliser. Available at <http://www.digitrm.co.uk/assets/Uploads/Granular-Bio-solid-Fertiliser.pdf> (accessed April 2018).
- Durrenmatt, D.J., and Wanner, O. (2014). A mathematical model to predict the effect of heat recovery on the wastewater temperature in sewers. *Water research*, 48, 548-558.
- El Diwani, G., El Rafie, S., El Ibiari, N. N., and El-Aila, H. I.

- (2007). Recovery of ammonia nitrogen from industrial wastewater treatment as struvite slow releasing fertilizer. *Desalination*, 214(1-3), 200-214.
- European Commission (1999). Reference document on best available techniques in the pulp and paper industry. Available at <http://portal.mma.gob.cl/wp-content/uploads/2017/06/Integrated-Pollution-Prevention-and-Control-Draft-Reference.pdf> (accessed April 2018).
- European Commission (2007). Reference document on best available techniques for the manufacture of large volume inorganic chemicals - solids and others industry. Available at [http://www.prtr-es.es/data/images/BREF%20Industria%20Química%20Inorgánica%20de%20gran%20volumen%20de%20producción%20\(sólidos%20y%20otros%20productos\)-02FDB2732F82B5AE.pdf](http://www.prtr-es.es/data/images/BREF%20Industria%20Química%20Inorgánica%20de%20gran%20volumen%20de%20producción%20(sólidos%20y%20otros%20productos)-02FDB2732F82B5AE.pdf) (accessed March 2018).
- European Commission (2010). Reference document on best available techniques in the cement, lime and magnesium oxide manufacturing industries. Available at http://eippcb.jrc.ec.europa.eu/reference/BREF/clm_bref_0510.pdf (accessed March 2018).
- European Commission (2015). From the sugar platform to biofuels and biochemicals. Available at <https://ec.europa.eu/energy/sites/ener/files/documents/EC%20Sugar%20Platform%20final%20report.pdf> (accessed April 2018).
- FinancialBuzz (2018). The Demand for Magnesium is Projected to Grow. Available at https://www.morningstar.com/news/pr-news-wire/PRNews_20180316enUK201803164615/the-demand-for-magnesium-is-projected-to-grow.print.html (accessed March 2018).
- Gellings and Parmenter (2004). Energy efficiency in fertilizer production and use, in *Efficient use and conservation of energy*, Eds. Gellings and Blok, in *Encyclopedia of Life Support Systems*, developed under the Auspices of the UNESCO, Eolss Publishers, Oxford, UK.
- Herring, J.R., and Fantel, R.J. (1993). Phosphate rock demand into the next century: impact on world food supply. *Nonrenewable Resources*, 2(3), 226-246.
- Honda, S. I., Miyata, N., and Iwahori, K. (2002). Recovery of biomass cellulose from waste sewage sludge. *Journal of Material Cycles and Waste Management*, 4(1), 46-50.
- ICIS (2005). Chemical Profile Ferrous Sulphate. Available at <https://www.icis.com/resources/news/2005/12/02/517817/chemical-profile-ferrous-sulfate/> (accessed March 2018).
- Inguanzo, M., Domínguez, A., Menéndez, J. A., Blanco, C. G., and Pis, J. J. (2002). On the pyrolysis of sewage sludge: the influence of pyrolysis conditions on solid, liquid and gas fractions. *Journal of Analytical and Applied Pyrolysis*, 63(1), 209-222.
- IM (2016). Industrial minerals prices. Available at <http://www.geotech.cu/wp-content/uploads/2016/09/Precios-minerales-industriales.-IM-agosto-2016.pdf> (accessed March 2018).
- Karlsson, A. N. T. O. N. (2010). Production of polyhydroxyalkanoates in an open mixed culture from fermented hydrolyzed sludge under high organic loading rates. *Water Research*, 44, 5196-5211.
- Lasprilla, A. J., Martinez, G. A., Lunelli, B. H., Jardini, A. L., and Maciel Filho, R. (2012). Poly-lactic acid synthesis for application in biomedical devices—A review. *Biotechnology advances*, 30(1), 321-328.
- Latimer, R., Nguyen, V., Vadiveloo, E., Pitt, P., Harris, R., Porter, R., Elmendorf, H. and Richards, T. (2012). Pilot testing nutrient recovery from WAS streams for struvite control and recycle load reduction. *Proceedings of the Water Environment Federation*, 2012(17), 489-511.
- Liew, T. K., King, L. S., Haur, C. J., and Yu, L. C. (2014). Overview of poly (lactic acid) production with oil palm biomass as potential feedstock. *International Journal of Engineering and Applied Sciences*, 5(4), 1-10.
- Maurer, M., Muncke, J., and Larsen, T. A. (2002). Technologies for nitrogen recovery and reuse. In Lens, P., Hulshoff Pol, L., Wilderer, P. and Asano, *Water and Resource Recovery in Industry*. IWA Publishing, 491-510.
- Mihelcic, J.R., Fry, L.M. and Shaw, R. (2011). Global potential of phosphorus recovery from human urine and faeces. *Chemosphere*, 84(6), 832-839.
- National statistics (2016). Key Scottish Environment Statistics 2016. www.gov.scot/Resource/0050/00508344.pdf (accessed January 2018).
- Neugebauer, G., Kretschmer, F., Kollmann, R., Narodslawsky, M., Ertl, T., and Stoeglehner, G. (2015). Mapping thermal energy resource potentials from wastewater treatment plants. *Sustainability*, 7(10),

12988-13010.

- Nges, I. A., and Liu, J. (2010). Effects of solid retention time on anaerobic digestion of dewatered-sewage sludge in mesophilic and thermophilic conditions. *Renewable Energy*, 35(10), 2200-2206.
- NREL (2001). Life Cycle Assessment of Hydrogen Production via Natural Gas Steam Reforming. Available at <https://www1.eere.energy.gov/hydrogenandfuelcells/pdfs/27637.pdf> (accessed March 2018).
- Orozco, F. G., Valadez-González, A., Domínguez-Maldonado, J. A., Zuluaga, F., Figueroa-Oyosa, L. E., and Alzate-Gaviria, L. M. (2014). Lactic acid yield using different bacterial strains, its purification, and polymerization through ring-opening reactions. *International Journal of Polymer Science*, 2014.
- Plastics Europe (2005). Eco-profiles of the European plastics industry: polypropylene (PP). Available at http://www.inference.org.uk/sustainable/LCA/elcd/external_docs/pp_31116f04-fabd-11da-974d-0800200c9a66.pdf (accessed May 2018).
- Quist-Jensen, C.A., Macedonio, F. and Drioli, E. (2015). Membrane technology for water production in agriculture: desalination and wastewater reuse. *Desalination*, 364, 17-32.
- Randolph, B., and Troy, P. (2008). Attitudes to conservation and water consumption. *environmental science and policy*, 11(5), 441-455.
- Renewable energy focus (2009). Hydrogen production from renewables. Available at <http://www.renewableenergyfocus.com/view/3157/hydrogen-production-from-renewables/> (accessed March 2018).
- Ronteltap, M., Maurer, M., and Gujer, W. (2007). Struvite precipitation thermodynamics in source-separated urine. *Water Research*, 41(5), 977-984.
- Rudnik, E. (2010). *Compostable polymer materials*. Elsevier.
- Ruiken, C. J., Breuer, G., Klaversma, E., Santiago, T., and Van Loosdrecht, M. C. M. (2013). Sieving wastewater-Cellulose recovery, economic and energy evaluation. *Water research*, 47(1), 43-48.
- Rusten, B., Razafimanantsoa, V. A., Andriamiarinjaka, M. A., Otis, C. L., Sahu, A. K., and Bilstad, T. (2016). Impact of fine mesh sieve primary treatment on nitrogen removal in moving bed biofilm reactors. *Water Science and Technology*, 73(2), 337-344.
- Saidani, M., Yannou, B., Leroy, Y., and Cluzel, F. (2017). How to Assess Product Performance in the Circular Economy? Proposed Requirements for the Design of a Circularity Measurement Framework. *Recycling*, 2(1), 6.
- Scottish Water (2006). National Sludge Strategy. Available at http://www2.scottishwater.co.uk/portal/page/portal/SW_PAGE_GROUP_PS_ADMIN/SW_PUB_SCHEME_ADMIN_HOLDING/TAB65572/National%20Sludge%20Strategy.pdf (accessed March 2018).
- Scottish Water (2017). Borders College Galashiels. Available at <http://www.scottishwater.co.uk/business/horizons/heat-from-waste-water/heat-from-waste-water/borders-college-galashiels> (accessed March 2018).
- Scottish Government (2018). Energy in Scotland 2018. Available at <http://www.gov.scot/Resource/0053/00531701.pdf> (accessed May 2018).
- Sin, L. T., Rahmat, A. R., and Rahman, W. A. (2013). Applications of poly (lactic Acid). In *Handbook of Biopolymers and Biodegradable Plastics*, 55-69.
- Sharpley, A.N., McDowell, R.W. and Kleinman, P.J. (2004). Amounts, forms, and solubility of phosphorus in soils receiving manure. *Soil science society of America journal*, 68(6), 2048-2057.
- Stanchev, P., Vasilaki, V., Dosta, J., and Katsou, E. (2017). Measuring the circular economy of water sector in the three-fold linkage of water, energy and materials. Available at http://uest.ntua.gr/athens2017/proceedings/pdfs/Athens2017_Stanchev_Vasilaki_Mousavi_Dosta_Katsou.pdf (accessed April 2017).
- Sprynskyy M., Lebedynets M., Zbytniewski R, Namieñnik J., Buszewski B. (2005). Ammonium removal from aqueous solution by natural zeolite, Transcarpathian mordenite, kinetics, equilibrium and column tests. *Sep Purif Technol.* 46(3):155–60
- Sun, D., Hale, L., Kar, G., Soolanayakanahally, R. and Adl, S. (2018). Phosphorus recovery and reuse by pyrolysis: Applications for agriculture and environment. *Chemosphere*, 194, 682-691.
- Sydney water (2010). Water conservation strategy. Available at https://www.sydneywater.com.au/web/groups/publicwebcontent/documents/document/zgrf/md-q1/~edisp/dd_045260.pdf (accessed April 2018)
- Thompson, K. A., Shimabuku, K. K., Kearns, J. P., Knappe, D. R., Summers, R. S., and Cook, S. M. (2016).

- Environmental comparison of biochar and activated carbon for tertiary wastewater treatment. *Environmental science and technology*, 50(20), 11253-11262.
- Tice, R. C., and Kim, Y. (2014). Energy efficient reconcentration of diluted human urine using ion exchange membranes in bioelectrochemical systems. *Water research*, 64, 61-72.
- UNESCO (2017). The United Nations World Water Development Report 2017. Wastewater: The Untapped Resource. Paris, UNESCO. Available at <http://unesdoc.unesco.org/images/0024/002471/247153e.pdf> (accessed February 2018).
- Valley water (2007). Water conservation rebates and incentives. Available at http://www.dtsc.ca.gov/PollutionPrevention/MFMS/upload/jlarabee_mfms.pdf (accessed April 2018).
- Van Leeuwen, K., de Vries, E., Koop, S., and Roest, K. (2018). The Energy and Raw Materials Factory: Role and Potential Contribution to the Circular Economy of the Netherlands. *Environmental management*, 61(5), 786-795.
- Villano, M., Beccari, M., Dionisi, D., Lampis, S., Miccheli, A., Vallini, G., and Majone, M. (2010). Effect of pH on the production of bacterial polyhydroxyalkanoates by mixed cultures enriched under periodic feeding. *Process Biochemistry*, 45(5), 714-723.
- Wang, Z., Chen, D., Song, X., and Zhao, L. (2012). Study on the combined sewage sludge pyrolysis and gasification process: mass and energy balance. *Environmental technology*, 33(22), 2481-2488.
- Wilderer, P. A. (2010). *Treatise on water science*. Newnes.
- WRAP (2018). Compost Calculator. Available at <http://www.wrap.org.uk/content/compost-calculator>. Accessed 09 February 2018.
- Yaman, S. (2004). Pyrolysis of biomass to produce fuels and chemical feedstocks. *Energy conversion and management*, 45(5), 651-671.
- Zero Waste Scotland (2010). Digestate market development in Scotland. Available at http://www.wrap.org.uk/sites/files/wrap/Zero_Waste_Scotland_Digestate_Market_Development.pdf (accessed March 2018).
- Zero waste Scotland (2016). The Scottish carbon metric. Available at <https://www.zerowastescotland.org.uk/sites/default/files/The%20Scottish%20Carbon%20Metric.pdf> (accessed January 2018).
- Zero Waste Scotland (2017). Biorefining Potential for Scotland. Available at <https://www.zerowastescotland.org.uk/sites/default/files/Biorefining%20Potential%20for%20Scotland%20Final%20report.pdf> (accessed 25 April 2018)

Appendix A: Raw data of the water composition

Table A-1 Wastewater characteristics across 41 sites (main wastewater treatment sites in Scotland on the basis of the treated flow rate). SS=Suspended solids; COD=Chemical Oxygen Demand

Site	Flow	COD	SS	NH ₄ -N	Ca	Cl	Fe	Mg	TN	P	K	T
	m ³ /day	mg/l	mg/l	mg/l	mg/l	mg/l	mg/l	mg/l	mg/l	mg/l	mg/l	°C
1	13755	552.9		26.1		110.9				4.7		
2	21970	312.4	177.0	25.5		105.7						
3	3957	501.7				417.9						
4	5693	229.2				116.9						
5	34983	693.5	2929.1	16.2		70.9						
6	7158	224.0	112.0	22.4					22.0	3.7		
7	10790	223.3				43.4	2.2			2.8		
8	20605	304.4		24.9		165.0				3.9		
9	23481	366.5		27.0		79.4				4.0		
10		335.3	130.5	4.6								
11	10028	341.6		23.4		60.6				3.9		
12	4325	517.6	521.0	25.0		103.6				6.8		
13	40791	300.0	148.5	19.5								
14	102755	400.2	251.0	23.9	46.5	115.2				3.6		12.6
15	112041	371.5	530.2	19.6	44.2	59.1	3.0			3.1		12.8
16	11314	435.7	293.6	26.2		85.5						13.0
17	3360	112.2		26.7		1096.0						
18	30382	341.3	237.2		49.8		1.1	15.0	21.4	4.6	13.2	
19	34625	221.7		20.9		189.8						
20	5695	460.2		24.7		106.1			23.4	5.5		
21		352.4		19.5	47.6			35.8	20.9		23.2	
22	27950	410.6		28.6		102.1				4.4		
23	3894	610.7		43.4		90.7				7.4		
24	11859	416.3	312.0			70.4						
25	21323	438.2	233.8	19.3		135.9						
26	18340	402.2				135.8						
27	64583	371.5	248.0	17.0					12.4			
28		169.7				785.7						
29	8569	126.2	48.2	11.7		77.3						
30	6805	251.2				669.3						
31	2878	535.9				111.9						
32		464.9										
33		415.7								3.0		
34	25245	494.6	2782.7	36.8		117.7			33.5			
35		424.0										
36	22278	390.7	348.5	25.1		102.2				4.5		
37	179986	258.8	64.4			89.8						
38	7419	403.1				93.7				0.8		
39	43105	683.2	778.9			111.6		8.3			15.3	
40	9448	247.2	155.1	22.2	30.2	133.8			16.2	3.1		12.4
41	14734	211.0				72.0						

Table A-2 Summary of the groundwater and surface water data used in the calculations.

Site	Ca	Fe	Mg	N	K
	mg/l	mg/l	mg/l	mg/l	mg/l
<i>Permo-Triassic aquifers</i>	37.5	0.01	17.2	3.9	1.7
<i>Carboniferous sedimentary aquifers</i>	58.7	0.05	27.2	0.7	4.4
<i>Carboniferous sedimentary aquifers (mined for coal)</i>	71.0	0.68	28.2	0.0	4.3
<i>Old Red Sandstone North aquifers</i>	61.6	0.03	8.1	0.7	2.6
<i>Old Red Sandstone South aquifers</i>	47.5	0.01	14.4	4.0	2.1
<i>Silurian and Ordovician aquifers</i>	39.1	0.01	12.5	2.5	1.2
<i>Highland Calcareous aquifers.</i>	62.8	0.01	4.8	1.6	2.4
<i>Precambrian North aquifers</i>	20.9	0.04	3.7	0.3	1.9
<i>Precambrian South aquifers</i>	17.4	0.04	4.5	1.8	1.5
<i>Igneous volcanic aquifers</i>	42.2	0.03	11.5	3.6	1.1
<i>Igneous intrusive aquifers</i>	20.0	0.02	6.7	3.0	1.4
<i>superficial aquifers</i>	35.1	0.00004	4.2	2.2	2.2
<i>Surface water</i>	20.80	0.57	5.91	1.1	2.07

Appendix B: Solid organic waste

Table B-1 Total production rate of solid organic waste in Scotland (Zero Waste Scotland, 2017).

Feedstock	Total waste (tonnes of dry matter)
Animal and mixed food waste	69,869
Animal faeces, urine, and manure	28,748
Vegetal waste	76,190
By-product of brewing, distilling, cheese making, abattoir and fish processing	840,283
Agricultural waste	5,015,639
Sewage sludge	114,725
Total	6,145,454

Appendix C: Market trends

Market trends of some of the considered resources are presented here to aid in future predictions for resource values. The fertiliser prices were converted into £ terms from US\$, in which the prices are reported initially. The prices were also converted from product tonnes into nutrient kg. The illustrated market trend in Figure C-1 suggests a further decrease in fertiliser prices. However, slightly higher rates were used in the calculations, due to different data sources and fiscal year. Natural gas prices have been steadily increasing over the last two years (Figure C-2).

Figure C-3 shows a 5-year market trend of wood pulp (raw material for cellulose production). The price has declined during the past months.

The market trends for ferrous sulphate, calcium carbonate, magnesium oxide and other organic materials were not available. The market trend for iron sulphate can be implied indirectly from the price of titanium dioxide which is projected to grow from 2016 to 2021.

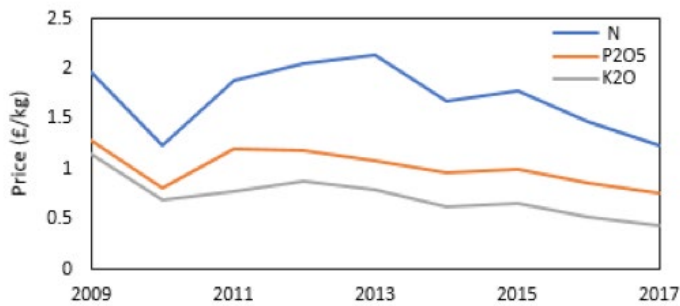

Figure C-1 Fertiliser Prices between 2009 and 2017
Source: Department of Agricultural and Consumer Economics, University of Illinois¹



Figure C-2 Natural gas market trend over 5 years
Source: indexmundi²



Figure C-3 Implied cellulose market trend based on wood pulp prices
Source: indexmundi³

¹<http://farmdocdaily.illinois.edu/pdf/fdd110717.pdf>

²<https://www.indexmundi.com/commodities/?commodity=natural-gas&months=60¤cy=gbp>

³<https://www.indexmundi.com/commodities/?commodity=wood-pulp&months=60¤cy=gbp>



Scotland's centre of expertise for waters

CREW Facilitation Team

James Hutton Institute

Craigiebuckler

Aberdeen AB15 8QH

Scotland UK

Tel: +44 (0)1224 395 395

Email: enquiries@crew.ac.uk

www.crew.ac.uk



Scottish
Government
gov.scot

CREW is a Scottish Government funded partnership between
the James Hutton Institute and Scottish Universities.

